

# SE-1515

PC ECG

Version 1.8

# User Manual

CE<sub>0123</sub>

  
EDAN

## **About this Manual**

P/N: 01.54.455911

MPN: 01.54.455911018

Release Date: Oct. 2016

© Copyright EDAN INSTRUMENTS, INC. 2013-2016. All rights reserved.

## **Statement**

This manual will help you understand the operation and maintenance of the product better. It is reminded that the product shall be used strictly complying with this manual. User's operation failing to comply with this manual may result in malfunction or accident for which EDAN INSTRUMENTS, INC. (hereinafter called EDAN) cannot be held liable.

EDAN owns the copyrights of this manual. Without prior written consent of EDAN, any materials contained in this manual shall not be photocopied, reproduced or translated into other languages.

Materials protected by the copyright law, including but not limited to confidential information such as technical information and patent information are contained in this manual, the user shall not disclose such information to any irrelevant third party.

The user shall understand that nothing in this manual grants him, expressly or implicitly, any right or license to use any of the intellectual properties of EDAN.

EDAN holds the rights to modify, update, and ultimately explain this manual.

## **Responsibility of the Manufacturer**

EDAN only considers itself responsible for any effect on safety, reliability and performance of the equipment if:

Assembly operations, extensions, re-adjustments, modifications or repairs are carried out by persons authorized by EDAN, and

The electrical installation of the relevant room complies with national standards, and

The instrument is used in accordance with the instructions for use.

## **Terms Used in this Manual**

This guide is designed to give key concepts on safety precautions.

**WARNING**

A **WARNING** label advises against certain actions or situations that could result in personal injury or death.

**CAUTION**

A **CAUTION** label advises against actions or situations that could damage equipment, produce inaccurate data, or invalidate a procedure.

**NOTE**

A **NOTE** provides useful information regarding a function or a procedure.

# Contents

<b>Chapter 1 Safety Guidance .....</b>	<b>1</b>
1.1 Indications for Use/Intended Use.....	1
1.2 Warnings and Cautions.....	1
1.2.1 General Warnings.....	1
1.2.2 General Cautions.....	4
1.2.3 Operation Warnings for Wireless System .....	5
1.2.4 Preparation and Operation Warnings (for Exercise ECG) .....	6
1.2.5 Contraindications (for Exercise ECG) .....	7
1.3 List of Symbols .....	8
<b>Chapter 2 Introduction.....</b>	<b>10</b>
2.1 Wired SE-1515 System .....	11
2.1.1 Wired System Connection Diagram.....	11
2.1.2 Assembling the Wired System .....	12
2.1.3 ECG Sampling Box.....	13
2.2 Wireless SE-1515 System .....	14
2.2.1 Wireless System Connection Diagram.....	14
2.2.2 Assembling Wireless System .....	17
2.2.3 ECG Sampling Box.....	19
2.3 Installing the Software .....	21
2.3.1 Requirements of the PC .....	21
2.3.2 About Installation Window .....	22
2.4 Features .....	22
<b>Chapter 3 Preparations Before Operation.....</b>	<b>24</b>
3.1 Preparing the Patient .....	24
3.1.1 Instructing the Patient .....	24
3.1.2 Cleaning the Skin .....	24
3.2 Connecting the Electrodes of Wired System.....	25
3.3 Connecting the Electrodes of Wireless System.....	26
3.4 Attaching Electrodes .....	27
3.4.1 Attaching Electrodes for Resting ECG .....	27
3.4.2 Electrode Placement for Exercise ECG .....	32
3.4.3 Attaching the Reusable Electrodes.....	33
3.4.4 Attaching Disposable Electrodes.....	34
3.5 Inspection Before Test.....	35
<b>Chapter 4 ECG Sampling.....</b>	<b>37</b>
4.1 Initial Configuration.....	37
4.2 Entering Patient Information.....	37
4.2.1 Entering Patient Information Manually .....	38

4.2.2 Entering Patient Information by Using a Bar Code Reader .....	39
4.2.3 Retrieve Patient Information .....	39
4.3 Selecting the ECG Sampling Type.....	39
4.4 ECG Sampling .....	40
4.4.1 Resting ECG Sampling .....	40
4.4.2 STAT ECG.....	47
4.4.3 Exercise ECG Sampling.....	47
4.4.4 VCG Sampling .....	54
4.4.5 HRV ECG Sampling .....	54
<b>Chapter 5 ECG Analysis.....</b>	<b>55</b>
5.1 Resting ECG .....	55
5.1.1 Wave Analysis .....	55
5.1.2 Average Template .....	57
5.1.3 About the Detail Information Window.....	57
5.1.4 About the Rhythm Wave Window .....	58
5.1.5 History Record .....	58
5.1.6 About the Parameters .....	58
5.2 Exercise ECG .....	59
5.2.1 About the Summary Screen.....	59
5.2.2 About the All View Screen .....	61
5.2.3 About the ECG Strip Screen .....	62
5.2.4 ST Analysis .....	62
5.2.5 ST Trend.....	63
5.3 VCG .....	63
5.3.1 Displaying Vector ECG with All Plane and All Loop.....	64
5.3.2 Displaying Vector ECG with Frontal Plane and QRS Loop .....	66
5.3.3 Displaying 3D Vector ECG.....	67
5.4 HRV.....	68
5.5 Report Previewing.....	69
5.6 Report Printing.....	69
5.7 Saving ECG Reports .....	69
<b>Chapter 6 Archives.....</b>	<b>71</b>
6.1 All List.....	71
6.1.1 Record Display.....	71
6.1.2 Modifying Patient Information .....	71
6.1.3 Viewing Examination Records.....	72
6.1.4 Deleting Examination Records .....	72
6.1.5 Merging Examination Records .....	72
6.1.6 Searching Patient Records.....	72
6.1.7 Import.....	73

6.1.8 Export.....	73
6.2 Order List .....	74
6.2.1 New Order.....	74
6.2.2 Inbox .....	74
6.2.3 Searching Information.....	74
<b>Chapter 7 Statistics .....</b>	<b>75</b>
<b>Chapter 8 System Setup.....</b>	<b>76</b>
8.1 Basic Setup.....	76
8.2 Display Setup .....	77
8.3 Transmission Setup .....	77
8.4 Output File Setup .....	78
8.5 GDT Setup .....	79
8.6 DICOM Setup .....	79
8.7 HL7 Setup .....	80
8.8 Barcode Setup .....	80
8.9 Other Setup .....	81
8.9.1 Product Authorization .....	82
8.9.2 Advanced Setting .....	82
<b>Chapter 9 Hint Information.....</b>	<b>84</b>
<b>Chapter 10 Cleaning, Care and Maintenance .....</b>	<b>85</b>
10.1 General Points .....	85
10.2 Cleaning .....	85
10.2.1 Cleaning the Sampling Box .....	86
10.2.2 Cleaning the Patient Cable.....	86
10.2.3 Cleaning the Reusable Electrodes (for Resting ECG) .....	86
10.3 Disinfection.....	87
10.3.1 Disinfecting the Sampling Box .....	87
10.3.2 Disinfecting the Patient Cable.....	87
10.3.3 Disinfecting the Reusable Electrodes (for Resting ECG).....	87
10.4 Maintenance of ECG Sampling Box.....	88
<b>Chapter 11 Accessories .....</b>	<b>89</b>
<b>Chapter 12 Warranty &amp; Service .....</b>	<b>93</b>
12.1 Warranty .....	93
12.2 Contact Information .....	93
<b>Appendix 1 Technical Specifications .....</b>	<b>94</b>
A1.1 Safety Specifications .....	94
A1.2 Environment Specifications .....	94
A1.3 Physical Specifications.....	95
A1.4 Power Supply Specifications.....	95
A1.5 Performance Specifications.....	96

<b>Appendix 2 EMC Information.....</b>	<b>99</b>
<b>Appendix 3 Abbreviations .....</b>	<b>103</b>

## Chapter 1 Safety Guidance

This chapter provides important safety information related to the use of SE-1515.

### 1.1 Indications for Use/Intended Use

SE-1515 PC ECG is intended to acquire, process and store ECG signals from adult and pediatric patients undergoing stress exercise test or resting test. The SE-1515 PC ECG is intended to be used only in hospitals and healthcare facilities by doctors and trained healthcare professionals. The cardiogram recorded by the SE-1515 PC ECG can help users to analyze and diagnose heart diseases. However, the ECG with measurements and interpretive statements is offered to clinicians on an advisory basis only.

---

---

#### **WARNING**

1. This system is not designed for intracardiac use or direct cardiac application.
  2. This system is not intended for home use.
  3. This system is not intended for treatment or monitoring.
  4. This system is intended for use on adult and pediatric patients only.
  5. The results given by the system should be examined based on the overall clinical condition of the patient, and they cannot substitute for regular checking.
- 
- 

### 1.2 Warnings and Cautions

To use the system safely and effectively, firstly be familiar with the operation method of Windows and read the user manual in detail to be familiar with the proper operation method for the purpose of avoiding the possibility of system failure. The following warnings and cautions must be paid more attention to during the operation of the system.

#### 1.2.1 General Warnings

---

---

#### **WARNING**

1. The system is intended to be used by qualified physicians or personnel professionally trained. They should be familiar with the contents of this user manual before operation.
- 
-



---

---

**WARNING**

2. Only qualified service engineers can install this equipment, and only service engineers authorized by the manufacturer can open the shell. Otherwise, safety hazards may happen.
  3. **EXPLOSION HAZARD** - Do not use the system in the presence of flammable anesthetic mixtures with oxygen or other flammable agents.
  4. **SHOCK HAZARD** - The power receptacle must be a hospital grade grounded outlet. Never try to adapt the three-prong plug to fit a two-slot outlet.
  5. Only the patient cable and other accessories supplied by the manufacturer can be used. Or else, the performance and electric shock protection cannot be guaranteed. The system has been safety tested with the recommended accessories, peripherals, and leads, and no hazard is found when the system is operated with cardiac pacemakers or other stimulators.
  6. The use of patient cable and other accessories not supplied by the manufacturer may result in increased emissions or decreased immunity of the equipment.
  7. Make sure that all electrodes are connected to the patient correctly before operation.
  8. Ensure that the conductive parts of electrodes and associated connectors, including neutral electrodes, do not come in contact with earth or any other conducting objects.
  9. Disposable electrodes must be used during defibrillation.
  10. Electrodes of dissimilar metals should not be used; otherwise it may cause a high polarization voltage.
  11. The disposable electrodes can only be used for one time.
  12. Do not touch the patient, bed, table or the equipment while using the ECG together with a defibrillator.
  13. Do not touch accessible parts of electrical equipment and the patient simultaneously.
  14. The use of equipment that applies high frequency voltages to the patient (including electrosurgical equipment and some respiration transducers) is not supported and may produce undesired results. Disconnect the patient data cable from the ECG workstation, or detach the leads from the patient prior to performing any procedure that uses high frequency surgical equipment.
  15. Fix attention on the examination to avoid missing important ECG waves.
  16. **SHOCK HAZARD** - Don't connect non-medical electrical equipment, which has been supplied as a part of the system, directly to the wall outlet when the non-medical equipment is intended to be supplied by a multiple portable socket-outlet with an isolation transformer.
- 
-

---

---

**WARNING**

17. **SHOCK HAZARD** - Don't connect electrical equipment, which has not been supplied as a part of the system, to the multiple portable socket-outlet supplying the system.
  18. Do not connect any equipment or accessories that are not approved by the manufacturer or that are not IEC/EN 60601-1 approved to the system. The operation or use of non-approved equipment or accessories with the system is not tested or supported, and system operation and safety are not guaranteed.
  19. Any non-medical equipment (such as the external printer) is not allowed to be used within the patient vicinity (1.5m/6ft.).
  20. Do not exceed the maximum permitted load when using the multiple portable socket-outlet(s) to supply the system.
  21. Multiple portable socket-outlets shall not be placed on the floor.
  22. Do not use the additional multiple portable socket-outlet or extension cord in the medical electrical system, unless it's specified as part of the system by manufacturer. And the multiple portable socket-outlets provided with the system shall only be used for supplying power to equipment which is intended to form part of the system.
  23. Accessory equipment connected to the analog and digital interfaces must be certified according to the respective IEC/EN standards (e.g. IEC/EN 60950 for data processing equipment and IEC/EN 60601-1 for medical equipment). Furthermore all configurations shall comply with the valid version of the standard IEC/EN 60601-1. Therefore anybody, who connects additional equipment to the signal input or output connector to configure a medical system, must make sure that it complies with the requirements of the valid version of the system standard IEC/EN 60601-1. If in doubt, consult our technical service department or your local distributor.
  24. Connecting any accessory (such as external printer) or other device (such as the computer) to this ECG workstation makes a medical system. In that case, additional safety measures should be taken during installation of the system, and the system shall provide:
    - a) Within the patient environment, a level of safety comparable to that provided by medical electrical equipment complying with IEC/EN 60601-1, and
    - b) Outside the patient environment, the level of safety appropriate for non-medical electrical equipment complying with other IEC or ISO safety standards.
  25. All the accessories connected to system must be installed outside the patient vicinity, if they do not meet the requirement of IEC/EN 60601-1.
  26. Make sure that there is no intense electromagnetic interference source around when using the wireless system of SE-1515. Furthermore, keep an unobstructed distance of at most 5 meters between DX12 transmitter and the PC.
- 
-

---

---

**WARNING**

27. You should purchase computer, printer, treadmill, ergometer, BP monitor and bar code reader from the manufacturer. Otherwise, the manufacturer will not be held responsible for the maintenance of the PC hardware, operating system and other accessories.
  28. If multiple instruments are connected to a patient, the sum of the leakage currents may exceed the limits given in the IEC/EN 60601-1 and may pose a safety hazard. Consult your service personnel.
  29. Connecting to other devices may decrease the antistatic gradation of the system during operation.
  30. The system shall not be serviced or maintained while in use with a patient.
  31. The appliance coupler or mains plug is used as isolation means from supply mains. Position the ECG workstation in a location where the operator can easily access the disconnection device.
  32. The medical electrical equipment needs to be installed and put into service according to Appendix 2 EMC information.
  33. Portable and mobile RF communications equipment can affect medical electrical equipment, refer to the recommended separation distances provided in Appendix 2 EMC Information.
  34. The equipment should not be used adjacent to or stacked with other equipment, refer to the recommended separation distances provided in Appendix 2 EMC Information.
  35. Assembly of the ECG workstation and modifications during actual service life shall be evaluated based on the requirements of IEC60601-1.
  36. The device is MR unsafe. It is not intended for use in an MRI environment.
  37. Magnetic and electrical fields are capable of interfering with the proper performance of the device. For this reason make sure that all external devices operated in the vicinity of the device comply with the relevant EMC requirements. X-ray equipment or MRI devices are a possible source of interference as they may emit higher levels of electromagnetic radiation.
- 
- 

## 1.2.2 General Cautions

---

---

**CAUTION**

1. Avoid liquid splash and excessive temperature. The temperature must be kept between 5°C and 40°C during operation, and it should be kept between -20°C and 55°C during transportation and storage.
  2. Do not use the equipment in a dusty environment with bad ventilation or in the presence of corrosive.
- 
-

---

---

**CAUTION**

3. Make sure that there is no intense electromagnetic interference source around the equipment, such as radio transmitters or mobile phones etc. Attention: large medical electrical equipment such as electrosurgical equipment, radiological equipment and magnetic resonance imaging equipment etc. is likely to bring electromagnetic interference.
  4. The device and accessories are to be disposed of according to local regulations after their useful lives. Alternatively, they can be returned to the dealer or the manufacturer for recycling or proper disposal. Batteries are hazardous waste. Do NOT dispose of them together with house-hold garbage. At the end of their lives hand the batteries over to the applicable collection points for the recycling of waste batteries. For more detailed information about recycling of this product or battery, please contact your local Civic Office, or the shop where you purchased the product.
  5. Federal (U.S.) law restricts this device to sale by or on the order of a physician.
- 
- 

### 1.2.3 Operation Warnings for Wireless System

---

---

**WARNING**

1. Make sure that there is no intense electromagnetic interference source around the wireless system.
  2. Do not open the battery cover of the transmitter during operation.
  3. Improper operations may heat the battery, make it on fire, explode, destroyed or reduce its capacity. Please read the manual and the cautions carefully before using the battery.
  4. Batteries of the same model and specification as manufacture configuration should be used.
  5. **DANGER OF EXPLOSION** -- Do not reverse the anode and the cathode when installing the battery.
  6. Do not use the battery near fire or in an environment where the temperature is over 60°C; do not heat or splash the battery or throw it into fire or water.
  7. Do not destroy the battery; do not pierce battery with a sharp object such as a needle; do not hit with a hammer, step on or throw or drop to cause strong shock; do not disassemble or modify the battery.
  8. When leakage or foul smell is found, stop using the battery immediately. If your skin or cloth comes into contact with the leakage liquid, cleanse it with clean water at once. If the leakage liquid splashes into your eyes, do not wipe them. Irrigate them with clean water first and go to see a doctor immediately.
- 
-

---

---

**WARNING**

---

---

9. Properly dispose of or recycle the depleted battery according to local regulations.
  10. Remove the battery from the transmitter if the system won't be used for a long time.
- 
- 

### **1.2.4 Preparation and Operation Warnings (for Exercise ECG)**

---

---

**WARNING**

---

---

1. Test the safety stop (mushroom type) and safety stop (cord type) of the treadmill before using the system.
  2. During the exercise test, ensure that such tests are supervised by properly trained technician who meets competency requirements for exercise test supervision, fully trained in cardiopulmonary resuscitation, and is supported by a physician skilled in exercise testing or emergency medicine who is in close proximity for pretest assessment or compliance that may raise.
  3. Make sure that there is necessary valid first-aid equipment such as defibrillators, blood-pressure meters etc, and necessary valid medication in the exercise test room.
  4. Turn off the system power and disconnect the power cord from the wall outlet after using the system.
  5. Make sure that the power is turned off and the power cord is disconnected from the AC socket before defibrillation.
  6. Keep the four feet of the machine on the ground and make sure that it's stably working.
  7. The treadmill must be powered by the specific power outlet.
  8. Examine the treadmill/ergometer carefully before using it.
  9. The patient undergoing the exercise test should wear suitable clothes and shoes.
  10. Keep hands, hair, jewelry, and loose clothing away from moving parts.
  11. Don't let the patient stand on the running belt when starting the treadmill. The patient should stand on the foot rails and hold the handrails during start-up. Wait until the running belt is moving before placing feet on the belt.
  12. To avoid the static electricity, the patient should not wear loose clothing or clothing (such as nylon) that easily produces static electricity.
  13. Stop exercising immediately when the patient feels uncomfortable or something abnormal in the operation.
  14. Press down the safety stop (mushroom type) or pull out the safety stop (cord type) to stop the treadmill immediately when an emergency happens.
- 
-

## 1.2.5 Contraindications (for Exercise ECG)











### **Absolute Contraindications:**





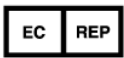

1. Acute MI (within 2 days)
2. High-risk unstable angina
3. Hemodynamic compromise caused by uncontrolled cardiac arrhythmia
4. Symptomatic severe aortic stenosis
5. Heart failure with clinic episode uncontrolled
6. Acute pulmonary embolus or pulmonary infarction
7. Acute myocarditis or pericarditis
8. Acute aortic dissection
9. The patient opposes the test.

### **Relative Contraindications:**

1. Left main coronary stenosis
2. Moderate stenotic valvular heart disease
3. Serum Electrolyte abnormalities
4. Severe hypertension (systolic blood pressure >200 mmHg or diastolic blood pressure >110 mmHg)
5. Tachyarrhythmias or bradyarrhythmias
6. Hypertrophic cardiomyopathy
7. Patients can not cooperate because of mental impairment or physical disability
8. High-degree AV block

## 1.3 List of Symbols

No.	Symbol	Description
1		DEFIBRILLATION-PROOF TYPE CF APPLIED PART
2		Caution
3		Operating instructions
4		General symbol for recovery/recyclable
5	P/N	Part Number
6		SERIAL NUMBER
7		Date of manufacture
8		MANUFACTURER
9		CLASS II equipment
10		AUTHORISED REPRESENTATIVE IN THE EUROPEAN COMMUNITY
11		Transmission Status Indicator of Bluetooth
12		Power Supply Indicator of DX12 Receiver

13	 ECG	Start printing button (on DE15&DE18)
14		CE marking
15		Disposal method
16	<b>Rx Only</b>	Caution: Federal (U.S.) law restricts this device to sale by or on the order of a physician.
17	FCC ID:SMQDX12TREDAN FCC ID:SMQDX12REEDAN	Federal Communications Commission: FCC ID:SMQDX12TREDAN (for DX12 Transmitter) FCC ID:SMQDX12REEDAN (for DX12 Receiver)
18		Refer to User Manual (Background: Blue; Symbol: White)
19		Warning (Background: Yellow; Symbol&Outline: Black)
20		Non- ionizing electromagnetic radiation
21		MR Unsafe - Keep away from magnetic resonance imaging (MRI) equipment

**NOTE:** The user manual is printed in black and white.



## Chapter 2 Introduction

The SE-1515 system consists of the following equipment:

- 18-lead ECG sampling system (18-lead ECG sampling box)  
Or, 16-lead ECG sampling system (16-lead ECG sampling box)  
Or, 12-lead wired ECG sampling system (12-lead ECG sampling box)  
Or, 12-lead wireless ECG sampling system (wireless DX12 transmitter and receiver)
- PC ECG software
- Patient cable
- Disposable electrodes
- USB cable

According to the configurations of different types of workstations, the following purchased accessories can also be included: tablet, computer, screen, printer, treadmill/ergometer, and exercise BP monitor.

**NOTE:** The pictures and windows in this manual are for reference only.

---

---

### **WARNING**

1. Use a special grounded socket to get accurate voltage and current.
  2. When using a laptop with a two-prong plug, please connect a grounded printer to avoid power interference.
  3. Only stress BP monitors can be used.
- 
-

## 2.1 Wired SE-1515 System

### 2.1.1 Wired System Connection Diagram

#### 1. Resting ECG of Wired SE-1515 System

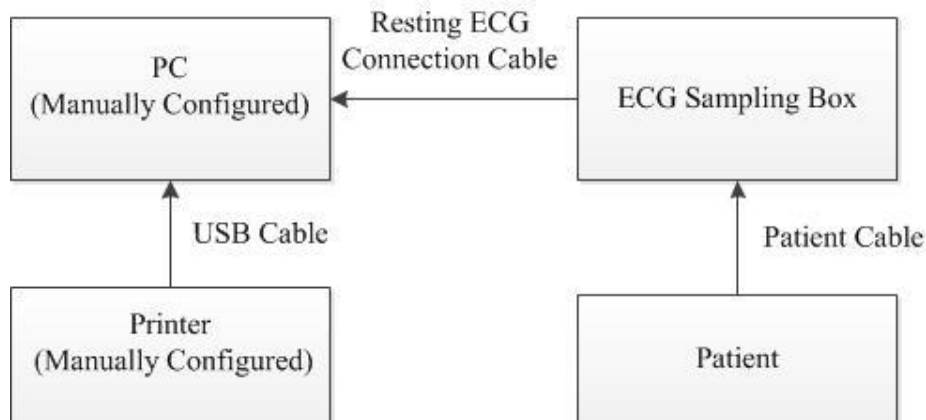

#### 2. Exercise ECG of Wired SE-1515 System

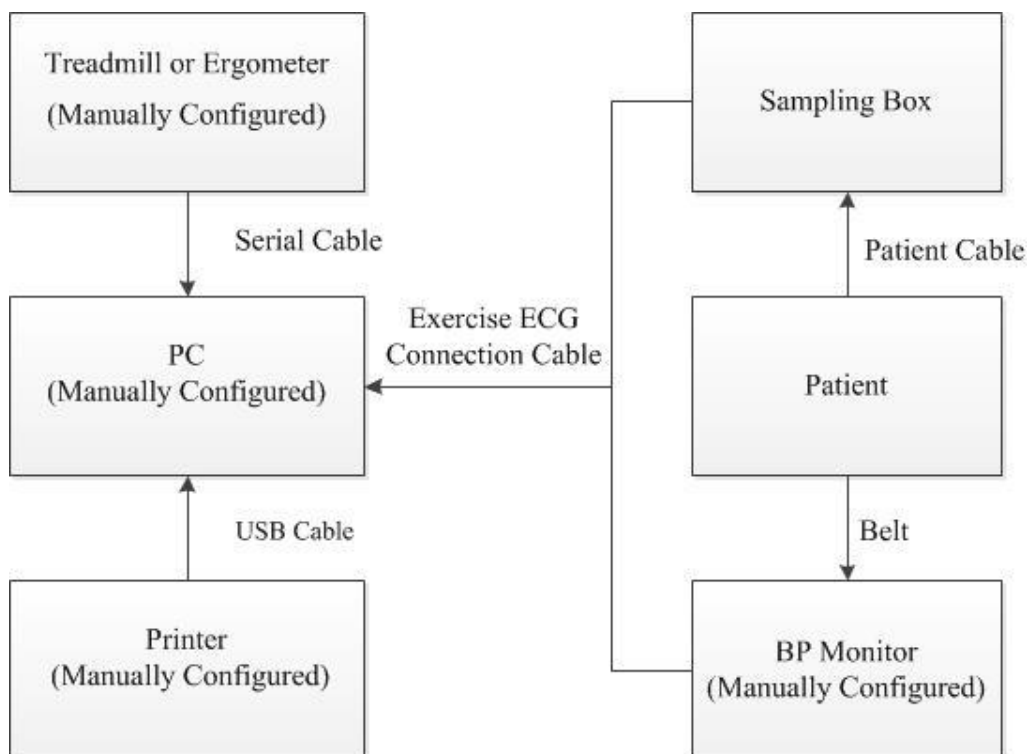

## 2.1.2 Assembling the Wired System

The DE15 ECG sampling box is used as an example here:

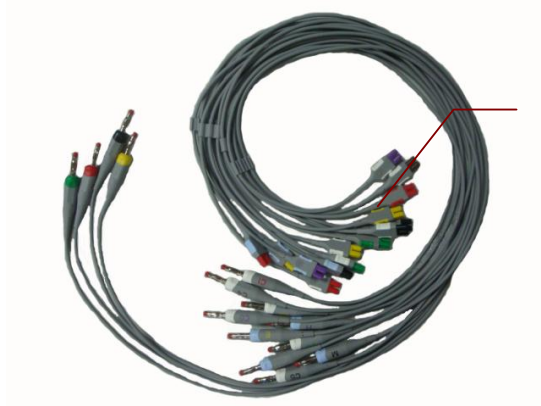

Patient Cable



DE15 ECG sampling box



Resting ECG Cable



Exercise ECG Cable



Assembly Drawing

- 1) Insert plug 1 of the patient cable into socket 2 of DE15 ECG sampling box.
- 2) Insert plug 7 of the cable into socket 3 of DE15 ECG sampling box.
- 3) Insert plug 8 of the cable into the USB socket of the PC.
- 4) Connect plug 6 of the cable to the BP monitor (for exercise ECG only).
- 5) Connect a treadmill or an ergometer to the PC (for exercise ECG only).
- 6) Connect a printer to the PC.
- 7) Insert the Sentinel into the USB socket of the PC if the Sentinel is purchased.
- 8) Make sure that the above parts are properly connected, and then connect the PC, treadmill/ergometer and printer to the power supply.

### 2.1.3 ECG Sampling Box

#### **WARNING**

1. When the computer connected to the USB cable is powered on, do not connect the USB cable to the ECG sampling box; when the system is powered on, do not disconnect the USB cable from the ECG sampling box.
2. It is not necessary or recommended to regularly disconnect the USB cable from the ECG sampling box. Disconnect the USB cable from the PC if necessary.
3. When connecting the sampling box to the PC, do not connect them via an USB HUB.
4. When a sampling box is connected the PC, no other device should be connected to the PC for battery enchargement through an USB cable.

#### 2.1.3.1 DE15/DE18 ECG sampling box

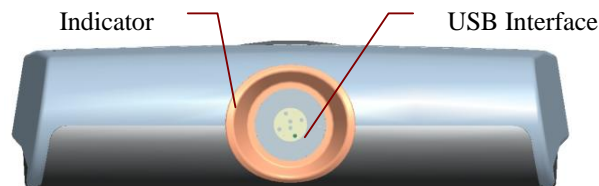

Name	Explanation
Indicator	When the ECG sampling box is powered by the PC, the indicator will be lit.
USB Interface	Connecting to the USB socket of the PC with a USB cable

### 2.1.3.2 DP12 ECG Sampling Box

- **Front Panel**

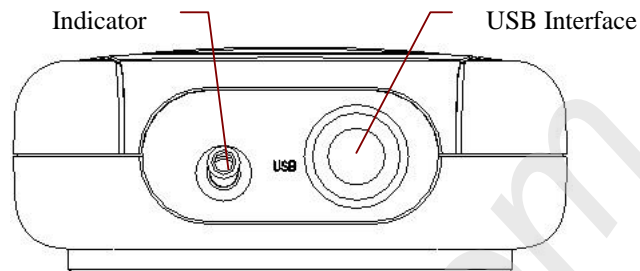

Name	Explanation
Indicator	When the ECG sampling box is powered by the PC, the indicator will be lit.
USB Interface	Connecting to the USB socket of the PC with a USB cable

## 2.2 Wireless SE-1515 System

### **WARNING**

This device complies with Part 15 of the FCC Rules.

Operation is subject to the following two conditions:

- 1) this device may not cause harmful interference, and
- 2) this device must accept any interference received, including interference that may cause undesired operation.

### **NOTE:**

1. This equipment has been tested and found to comply with the limits for a Class B digital device, pursuant to part 15 of the FCC Rules. These limits are designed to provide reasonable protection against harmful interference in a residential installation. This equipment generates, uses and can radiate radio frequency energy and, if not installed and used in accordance with the instructions, may cause harmful interference to radio communications. However, there is no guarantee that interference will not occur in a particular installation. If this equipment does cause harmful interference to radio or television reception, which can be determined by turning the equipment off and on, the user is encouraged to try to correct the interference by one or more of the following measures:
  - Reorient or relocate the receiving antenna.
  - Increase the separation between the equipment and receiver.
  - Connect the equipment into an outlet on a circuit different from that to which the

- receiver is connected.
- Consult the dealer or an experienced radio/TV technician for help.
2. Any changes or modifications to this unit not expressly approved by the party responsible for compliance could void the user's authority to operate the equipment.

### **2.2.1 Wireless System Connection Diagram**

The DX12 device which consists of transmitter and receiver has passed FCC certification. This device complies with Part 15 of the FCC Rules. Operation is subject to the following two conditions: (1) this device may not cause harmful interference, and (2) this device must accept any interference received, including interference that may cause undesired operation.

## 1 Resting ECG of Wireless System

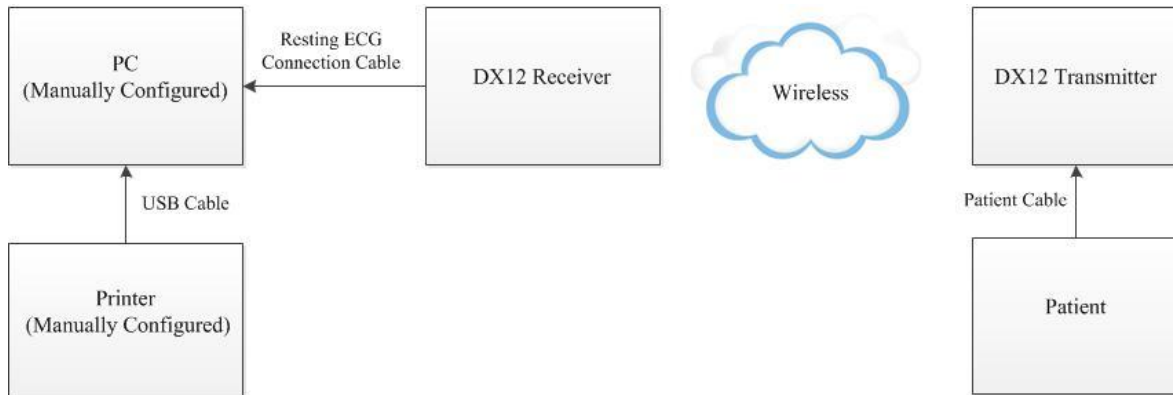

## 2 Exercises ECG of Wireless System

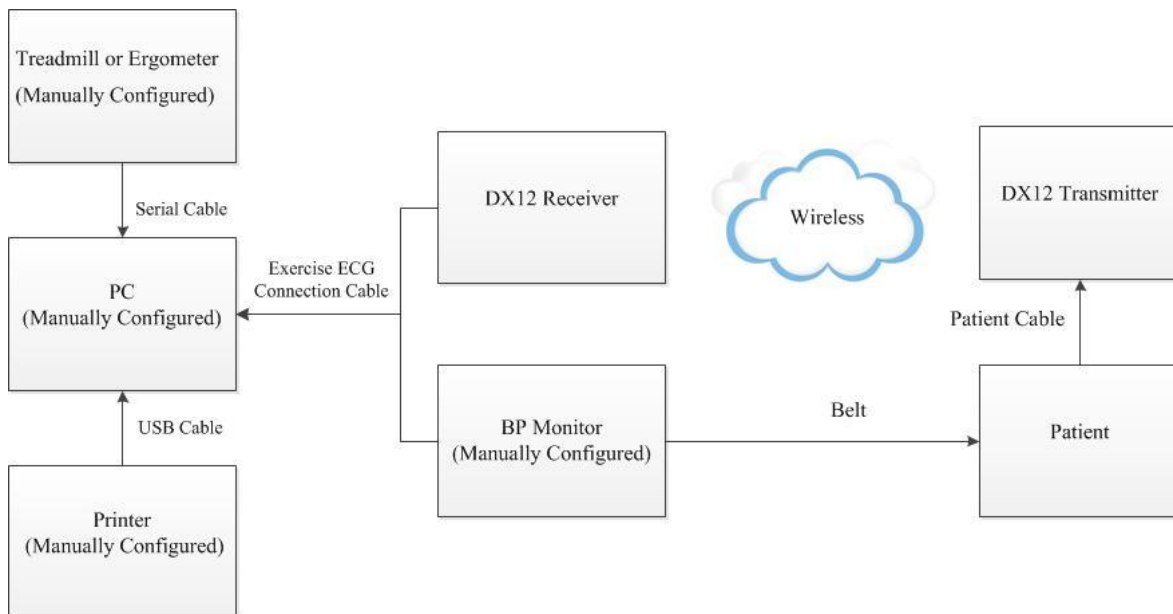

**NOTE:** The manufacturer is not responsible for any radio or TV interference caused by unauthorized modifications to this equipment. such modifications could void the user's authority to operate this equipment.

### **WARNING**

1. Accessory equipment connected to the analog and digital interfaces must be certified according to the respective IEC/EN standards (e.g. IEC/EN 60950 for data processing equipment and IEC/EN 60601-1 for medical equipment). Furthermore all configurations shall comply with the valid version of the standard IEC/EN 60601-1. Therefore anybody, who connects additional equipment to the signal input or output connector to configure a medical system, must make sure that it complies with the requirements of the valid version of the system standard IEC/EN 60601-1. If in doubt, consult our technical

service department or your local distributor.

2. The system should be installed by a qualified service engineer. Do not power on the system until all cables are properly connected and verified.
  3. If multiple instruments are connected to a patient, the sum of the leakage currents may exceed the limits given in the IEC/EN 60601-1 and may pose a safety hazard. Consult your service personnel.
  4. DX12 transmitter of the wireless system uses the Bluetooth technology, which could make the patient with the pacemaker uncomfortable. Keep DX12 transmitter far away from the pacemaker when using the wireless system of SE-1515.
- 

### 2.2.2 Assembling Wireless System



Patient Cable



DX12 Transmitter



DX12 Receiver





Resting ECG Cable



Exercise ECG Cable

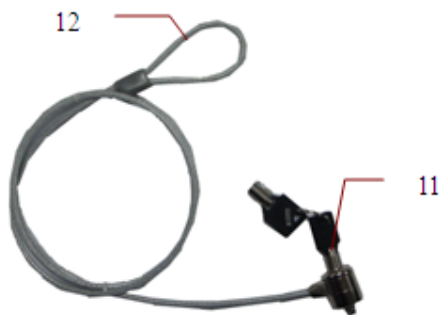

Burglar Lock

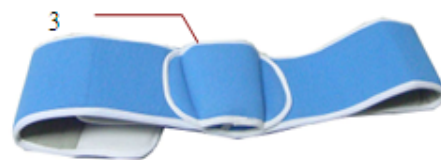

DX12 Belt



Drawing

Assembly

- 1) Insert plug 1 of the patient cable into socket 2 of DX12 transmitter.
- 2) Insert DX12 transmitter into pocket 3 of DX12 belt, and then wear the belt around the waist.
- 3) Insert plug 8 of the cable into socket 6 of the DX12 receiver.
- 4) Insert plug 9 of the cable into the USB socket of the PC.
- 5) Connect plug 10 of the cable to the BP monitor (for exercise ECG only).

- 6) Connect a treadmill or an ergometer to the PC (for exercise ECG only).
- 7) Connect a printer to the PC.
- 8) Insert the Sentinel into the USB socket of the PC if the sentinel is purchased.
- 9) Unlock burglar lock 11 and insert into the burglar lock keyhole of DX12 receiver, and fix the wireless system via the other end of the burglar lock.
- 10) Make sure that the above parts are properly connected, and then connect the PC, treadmill/ergometer and printer to the power supply.

## 2.2.3 ECG Sampling Box

### 2.2.3.1 Receiver

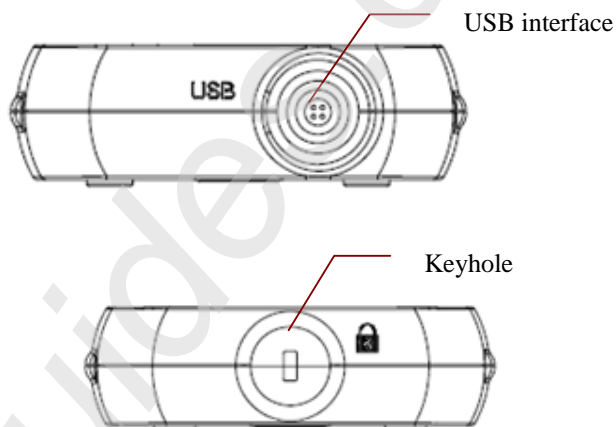

### 2.2.3.2 Transmitter

#### ◆ Button and Symbol

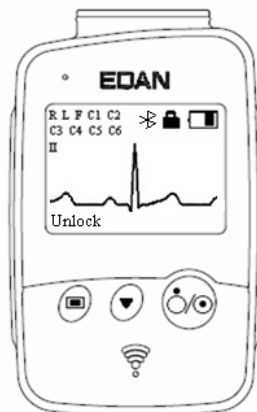









Figure 2-1 DX12 Transmitter Main Screen

Button	Explanation
	Switch on DX12 receiver and install batteries on DX12 transmitter. Press the button to start up DX12 transmitter, the main screen will be displayed.. When the main screen is displayed, press the button to return to previous menu.
	When the main screen or the setting screen is displayed, press the button to enter the next menu.  Press the button first, and press  within 1.2s to lock or unlock the keyboard.
	When the main screen is displayed, press the button to switch leads. When the menu screen is displayed, press the button to display one item in black.
	Bluetooth Connection Icon If the Bluetooth connection icon  is not displayed on the main screen, you have to match the device manually.
	Keyboard Lock Icon No operation within 8s, the keyboard will be locked automatically and the main screen is displayed.
	Battery Capacity Icon If the battery in the DX12 transmitter is low, hint will appear in the ECG station software.

#### ◆ Menu Settings



Make some settings on the DX12 transmitter according to actual use.

Menu	Description
------	-------------

Back Light	Select <b>On</b> to turn on the backlight of LCD screen. Select <b>Off</b> to turn off the backlight of LCD screen.
Auto Sleep	Select <b>On</b> to display <b>Sleeping</b> on the screen and make DX12 transmitter be in low power consumption mode after lead off for 5 minutes. Select <b>Off</b> to turn off auto sleep function.
Language	You can set the system language.
Lead Electrode	You can select <b>IEC</b> or <b>AHA</b> .
Match Device	<b>Inquiring</b> will be displayed (for 10 seconds) to search DX12 receiver. The address of DX12 receiver will be displayed (for 8 seconds) if a matching DX12 receiver is found. <b>No device found. Try again later</b> will be displayed (for 1 second) if no matching DX12 receiver is found.
Device Information	You can see the related information, such as software version, ID, address of DX12 receiver, manufacture and release time about the device.  <b>NOTE:</b> The device information is for reference only.

## 2.3 Installing the Software

### 2.3.1 Requirements of the PC

<b>CPU</b>	Pentium P4, Celeron D 310 or above
<b>System Memory (RAM)</b>	1G or above
<b>Main Board</b>	Recommend the main board of Intel chipset
<b>Hard Disk</b>	128G or above
<b>Printer</b>	ink jet printer of more than 300dpi or laser printer Recommend HP2035, HP2010, CANON iP1980
<b>Display</b>	17" TFT (Resolution: 1280*1024, 1366*768), 19" TFT (resolution: 1440×900), 21" TFT(1920*1080)
<b>Operating System</b>	Windows XP SP3 (32 bit), Windows 7 SP1 (32/64 bit) or Windows 8 (32/64 bit), Windows 8.1 (32/64 bit), Windows 10 (32/64 bit)

<b>Complied Standard</b>	IEC/EN 60950
--------------------------	--------------

**NOTE:** Ensure that there is a graphic driver installed in the PC. Otherwise, the displayed ECG waves may be abnormal.

### 2.3.2 About Installation Window

Insert the installation CD into CD-ROM, double-click on **Setup.exe** and then follow the directions to finish the installation.

For details on installing SE-1515 software, please refer to *SE-1515 PC ECG Installation Guide*.

## 2.4 Features

- ◆ 3-/6-/9-/12-/15-/16-/18-channel ECG waves are displayed and printed
- ◆ ECG waves can be frozen and reviewed
- ◆ Measurement point adjustment and re-analysis, manual measurement with an electronic ruler of high precision
- ◆ High performance filters guarantee stable ECG waveforms
- ◆ Perfect data management and processing functions
- ◆ Multiple report formats, including PDF, Word, JPG, and BMP
- ◆ Supporting multi-language
- ◆ Supporting auto measurement and diagnosis
- ◆ Editing the diagnosis templates

#### **The following features are only for the exercise test function**

- ◆ High-performance ECG filter, which ensures wave stability
- ◆ During sampling, it supports analyzing real-time HR, ST segment and ST trend, and displays and prints the simultaneous 12-lead ECG in real time.
- ◆ During sampling, you can perform ST segment analysis on the data of 12 leads, and adjust the ST segment place involved in lead analysis at any time.
- ◆ Analyzing arrhythmia automatically
- ◆ Providing summaries, ST analysis, wave reviews and trends
- ◆ Providing specific statistic data of each lead in each stage
- ◆ Providing average waves of each lead in each stage for you to observe the changes of ST segments among different stages
- ◆ Automatically generating delicate reports and providing report preview
- ◆ Providing classical exercise protocols; new exercise protocols can be added to the system

- ◆ Storing massive patient data in the computer, which enables you to review and analyze the exercise ECG in any time
- ◆ Automatically controlling and adjusting the speed and the elevation of the treadmill
- ◆ Supporting many kinds of treadmills and ergometers

## Chapter 3 Preparations Before Operation

### 3.1 Preparing the Patient

**NOTE:** Correct operation for the best-quality ECG is very important.

#### 3.1.1 Instructing the Patient

1. Before attaching the electrodes, greet the patient and explain the procedure. Explaining the procedure decreases the patient's anxiety.
2. Privacy is important for relaxation. When possible, prepare the patient in a quiet room or area where others can't see the patient. Use hangings beside the bed during ECG exam if other people are in the room.
3. Reassure the patient that the procedure is painless.
4. Make sure that the patient is comfortable.

Once the electrodes and patient cable are connected, inform the patients that:

- 1) No talking
- 2) Breathe smoothly
- 3) Try to be calm
- 4) Not to chew or keep his teeth firmly

The more relaxed the patient is, the less will the ECG wave is disturbed.

#### 3.1.2 Cleaning the Skin

The skin is a poor conductor of electricity and frequently creates artifacts that distort the ECG signals. There is natural resistance on the skin surface due to dry, dead epidermal cells, oils and dirt

##### **To clean the skin**

1. Shave hair from electrode sites, if necessary. Excessive hair prevents a good connection.
2. Wash the area thoroughly with soap and water.
3. Dry the skin to increase capillary blood flow and to remove the dead, dry skin cells and oils.
4. Use the disposable frosting film in the standard accessory list to get good ECG waveform.

**NOTE:** Rub the skin with a gauze pad to increase capillary blood flow if you don't operate the steps above.

**WARNING**

The performance and electric shock protection can be guaranteed only if the original patient cable and electrodes of the manufacturer are used.

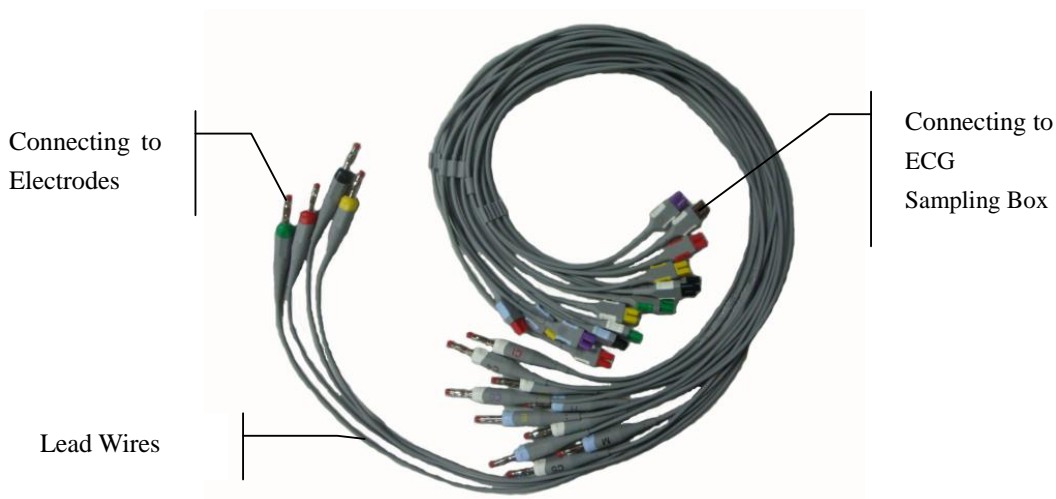
**3.2 Connecting the Electrodes of Wired System**

DE15 patient cable (Example)



12-Lead Patient Cable (Example)

The patient cable includes patient cable plugs and lead wires which can be connected to electrodes according to the colors and identifiers. The lead wires have 10 chest leads and 4 limb leads.

- ◆ Insert the patient cable plugs to the socket of ECG sampling box.
- ◆ Align all lead wires of the patient cable to avoid twisting, and connect the lead wires to the corresponding electrodes according to the colors and identifiers.



### 3.3 Connecting the Electrodes of Wireless System

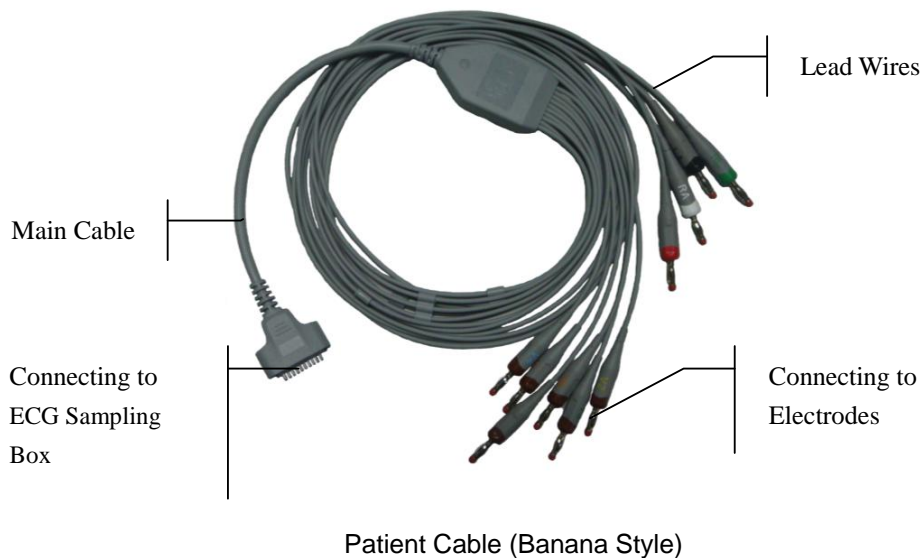
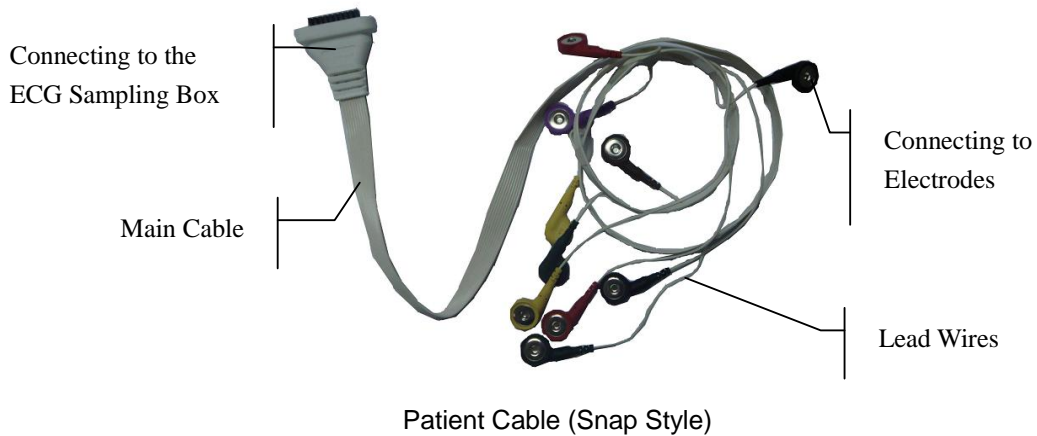

The patient cable includes patient cable plugs and lead wires which can be connected to electrodes according to the colors and identifiers. The lead wires have 10 chest leads and 4 limb leads.

- ◆ Insert the patient cable plugs to the socket of DX12 transmitter.
- ◆ Align all lead wires of the patient cable to avoid twisting, and connect the lead wires to the corresponding electrodes according to the colors and identifiers.

## 3.4 Attaching Electrodes

### 3.4.1 Attaching Electrodes for Resting ECG

#### **WARNING**

Make sure that the conductive parts of electrodes and associated connectors, including neutral electrodes, do not come in contact with earth or any other conducting objects.

The quality of ECG waveform will be affected by the contact resistance between the patient and the electrode. In order to get a high-quality ECG, the skin-electrode resistance must be minimized while connecting electrodes.

The identifiers and color codes of electrodes used comply with IEC/EN requirements. In order to avoid incorrect connections, the electrode identifiers and color codes are specified in Table 3-1.

Table 3-1 Electrodes and their identifiers and color codes

IEC		AHA	
Electrodes	Color Code	Electrodes	Color Code
R	Red	RA	White
L	Yellow	LA	Black
N/RF	Black	RL	Green
F	Green	LL	Red
C1	White/Red	V1	Brown/Red
C2	White/Yellow	V2	Brown/Yellow
C3	White/Green	V3	Brown/Green
C4	White/Brown	V4	Brown/Blue
C5	White/Black	V5	Brown/Orange
C6	White/Violet	V6	Brown/Violet
C3R	White/Pink	V3R	Brown/Yellow
C4R	White/Gray	V4R	Brown/Red
C5R	White/Green	V5R	Brown/Green
C7	White/Orange	V7	Brown/Black
C8	White/Blue	V8	Brown/Blue

C9	White/Yellow	V9	Brown/Yellow
H	Light blue/Violet/	H	Orange/Violet
E	Light blue/ Yellow	E	Orange/Yellow
I	Light blue/ Red	I	Orange/ Red
M	Light blue/ Black	M	Orange/Black

◆ **Standard 12-Lead Placement**

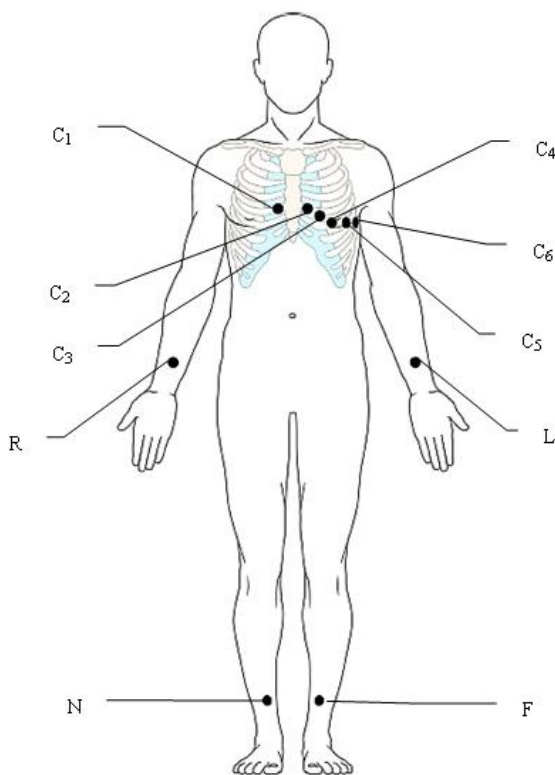

Only for the Reusable Electrodes

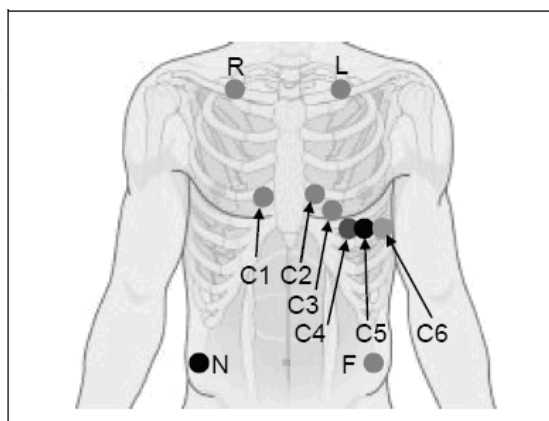

Only for the Disposable Electrodes

IEC	AHA	Electrode Placement
C1	V1	Fourth intercostal space at the right border of the sternum
C2	V2	Fourth intercostal space at the left border of the sternum
C3	V3	Fifth rib between C2 and C4
C4	V4	Fifth intercostal space on the left midclavicular line
C5	V5	Left anterior axillary line at the horizontal level of C4
C6	V6	Left midaxillary line at the horizontal level of C4
L	LA	Left arm/Left deltoid

R	RA	Right arm/Right deltoid
F	LL	Left leg/Upper leg as close to torso as possible
N	RL	Right leg/Upper leg as close to torso as possible

◆ **Standard+XYZ**

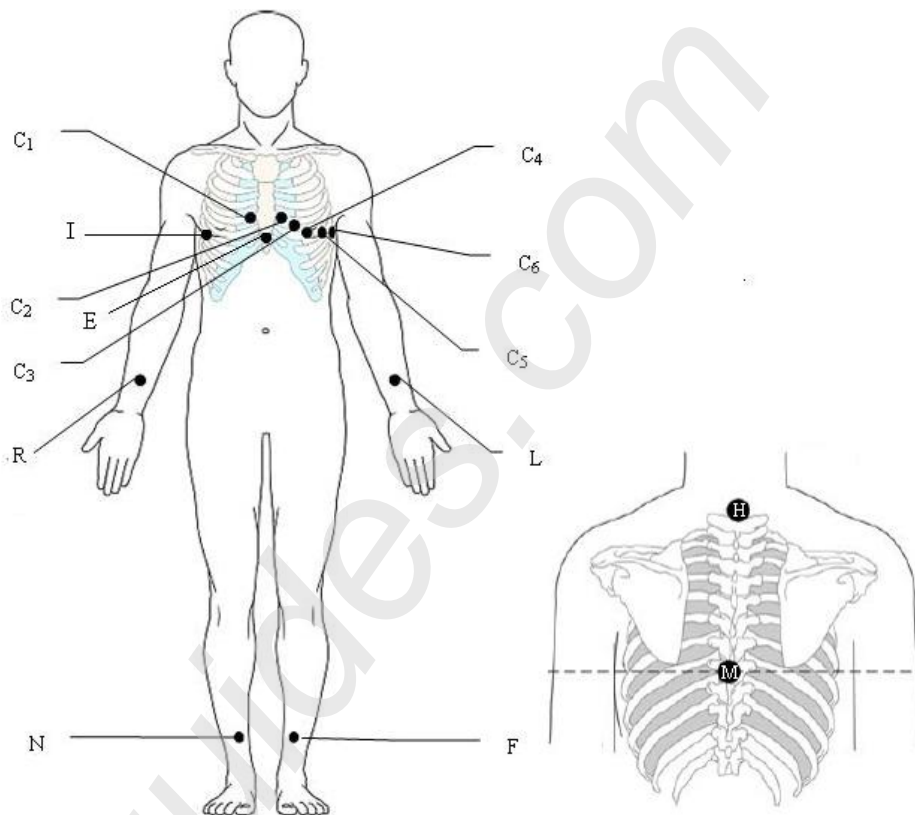

IEC	AHA	Electrode Placement
C1	V1	Fourth intercostal space at the right border of the sternum
C2	V2	Fourth intercostal space at the left border of the sternum
C3	V3	Fifth rib between C2 and C4
C4	V4	Fifth intercostal space on the left midclavicular line
C5	V5	Left anterior axillary line at the horizontal level of C4
C6	V6	Left midaxillary line at the horizontal level of C4
L	LA	Left arm/Left deltoid
R	RA	Right arm/Right deltoid
F	LL	Left leg/Upper leg as close to torso as possible
N	RL	Right leg/Upper leg as close to torso as possible

H	H	Back of neck, avoid the carotid artery and jugular vein.
E	E	Mid-sternum on the same horizontal level as C4 and C6.
I	I	Right mid-axillary line on the same horizontal level as C4 and C6.
M	M	Center of spine on the same horizontal level as C4 and C6

◆ **Frank Lead Placement (for VCG)**

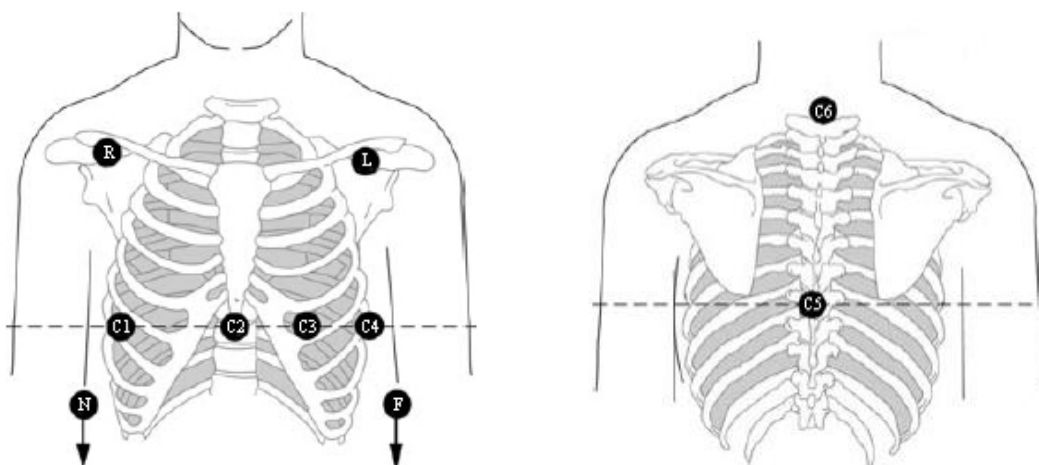

IEC	AHA	Electrode Placement
C1 (Corresponding to I)	V1 (Corresponding to I)	Right mid-axillary line on the same horizontal level as C3 and C4
C2 (Corresponding to E)	V2 (Corresponding to E)	Sternum at the level of C3 and C4
C3 (Corresponding to C)	V3 (Corresponding to C)	Mid-clavicular line in the fifth intercostals space
C4 (Corresponding to A)	V4 (Corresponding to A)	Left mid-axillary line on the same horizontal level as C3
C5 (Corresponding to M)	V5 (Corresponding to M)	Center of spine on the same horizontal level as C3 and C4
C6 (Corresponding to H)	V6 (Corresponding to H)	Neck, avoid carotid artery and jugular vein
L	LA	Left arm/Left deltoid
R	RA	Right arm/Right deltoid
F	LL	Left leg/Upper leg as close to torso as possible

N	RL	Right leg/Upper leg as close to torso as possible
---	----	---

◆ **NEHB Placement**

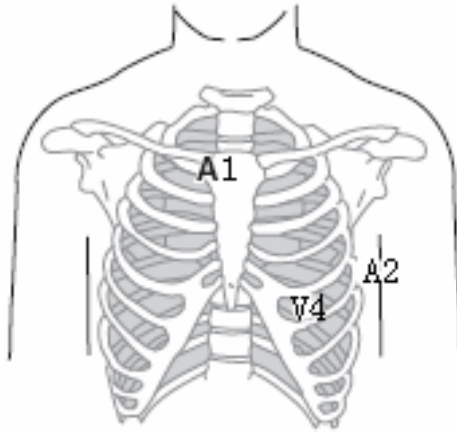

IEC	AHA	Electrode Placement
N <sub>st</sub> /C3R	A1/V3R	Attachment point of the second rib to the right sternal edge
N <sub>ax</sub> /C4R	A2/V4R	Fifth intercostal space on the left posterior axillary line
N <sub>ap</sub> /C4	V4	Left mid-clavicular line in the fifth intercostal space

◆ **V3R+V4R +V5R (Right)**

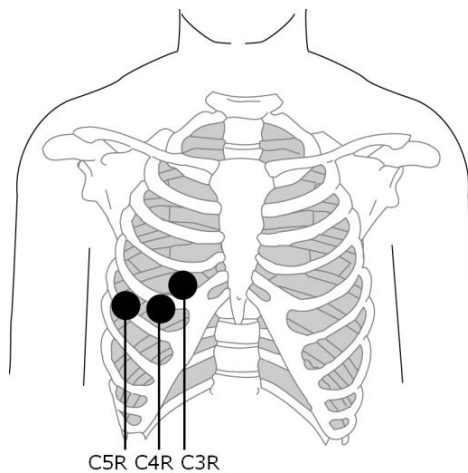

IEC	AHA	Electrode Placement
C3R	V3R	Right anterior chest opposite of C3
C4R	V4R	Right anterior chest opposite of C4
C5R	V5R	Right anterior chest opposite of C5

◆ V7+V8+V9 (Back)

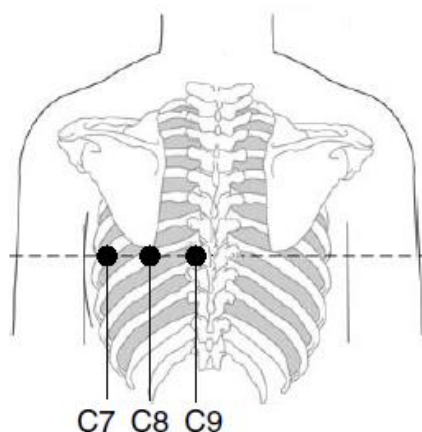

DE18:

IEC	AHA	Electrode Placement
C7	V7	Left posterior axillary line on the same horizontal level as C4 and C6
C8	V8	Left midscapular line on the same horizontal level as C4 and C7
C9	V9	Left paraspinal border on the same horizontal level as C4 and C8

DE15:

IEC	AHA	Electrode Placement
C7	V7	Left posterior axillary line on the same horizontal level as C4 and C6
C8/V5R	V8/V5R	Left midscapular line on the same horizontal level as C4 and C7
C9/V4R	V9/V4R	Left paraspinal border on the same horizontal level as C4 and C8

3.4.2 Electrode Placement for Exercise ECG

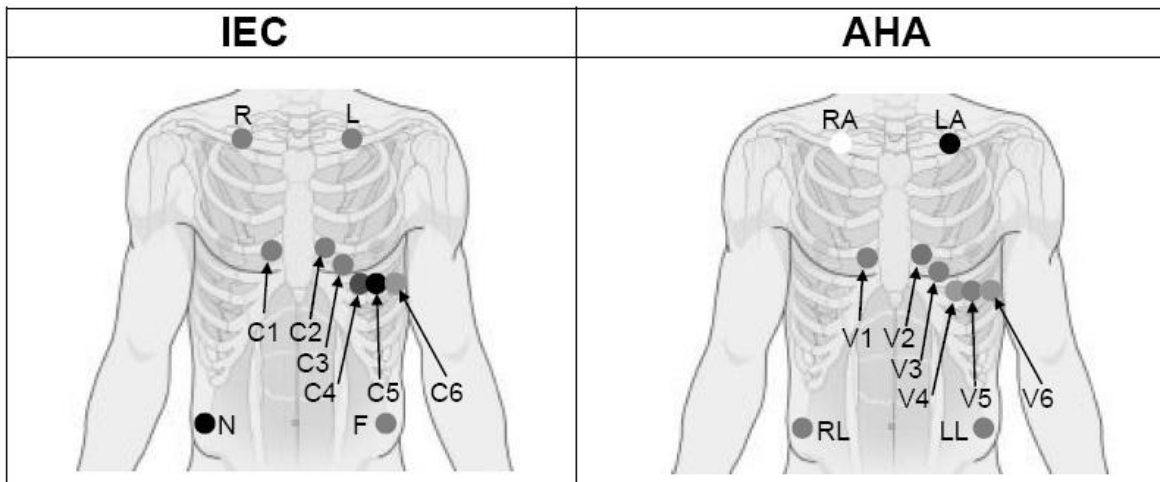

**The Precordial Electrodes' Positions on Body Surface:**

IEC	AHA	Electrode Placement
C1	V1	Fourth intercostal space at the right border of the sternum
C2	V2	Fourth intercostal space at the left border of the sternum
C3	V3	Fifth rib between C2 and C4
C4	V4	Fifth intercostal space on the left midclavicular line
C5	V5	Left anterior axillary line at the horizontal level of C4
C6	V6	Left midaxillary line at the horizontal level of C4

**The Extremity Electrodes' Positions on Body Surface:**

IEC	AHA	Electrode Placement
R / L	RA / LA	Below the right/left clavicle
N / F	RL / LL	Below the right/left rib

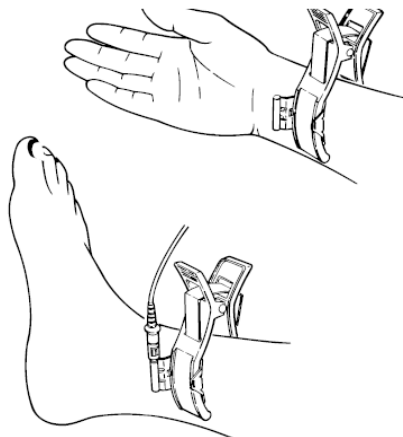
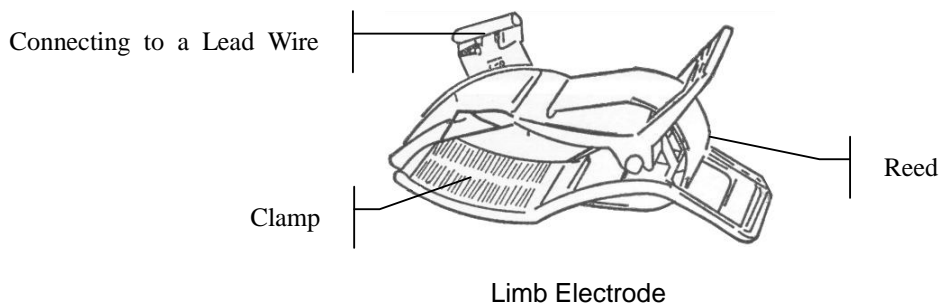
**3.4.3 Attaching the Reusable Electrodes****3.4.3.1 Attaching the Limb Electrodes****Limb Electrode Connection:**

- 1) Ensure that the electrodes are clean;
- 2) Clean the electrode area which is a short distance above the ankle or the wrist with 75% alcohol;
- 3) Daub the electrode area on the limb with gel evenly;
- 4) Place a small amount of gel on the metal part of the limb electrode clamp;
- 5) Connect the electrode to the limb, and make sure that the metal part is placed on the electrode area above the ankle or the wrist;
- 6) Attach all limb electrodes in the same way.



### 3.4.3.2 Attaching the Chest Electrodes

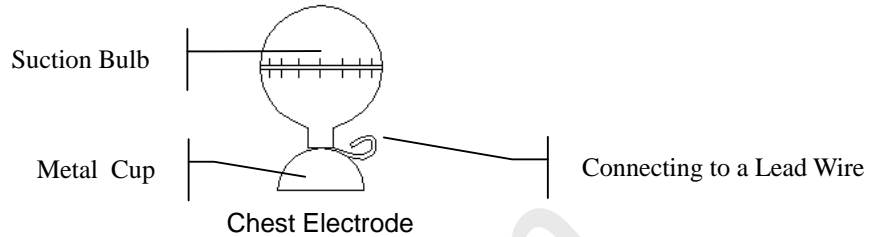

#### Chest Electrode Connection:

- 1) Ensure that the electrodes are clean;
- 2) Clean the electrode area on the chest surface with 75% alcohol;
- 3) Daub the round area of 25mm in diameter on each electrode site with gel evenly;
- 4) Place a small amount of gel on the brim of the chest electrode's metal cup;
- 5) Place the electrode on the chest electrode site and squeeze the suction bulb. Unclench it and the electrode is adsorbed on the chest;
- 6) Attach all chest electrodes in the same way.

**NOTE:** Long-time measurement with a strong negative pressure on the suction bulb may cause reddening of the skin. When using the electrode on kids or patients with delicate skin, squeeze the suction bulb lightly.

### 3.4.4 Attaching Disposable Electrodes

#### Disposable Electrode (clip style):



#### Alligator Clip:



#### Disposable Electrode Connection (Clip Style)

- 1) Align all lead wires of the patient cable to avoid twisting, and connect the alligator clips to the patient cable.

- 2) Clean the electrode areas on the body surface with 75% alcohol.
- 3) Attach the disposable electrodes to the electrode positions on the body surface.
- 4) Clip the disposable electrodes with the alligator clips.

Snap/Banana Socket Adapters



Disposable Electrode (Snap Style)



### Disposable Electrode Connection (Snap Style)

- 1) Align all lead wires of the patient cable to avoid twisting, and connect Snap/Banana Socket Adapters to connector of patient cable.
- 2) Clean the electrode areas on the body surface with 75% alcohol.
- 3) Attach the disposable electrodes to the electrode positions on the body surface.
- 4) Connect Snap/Banana Socket Adapters to the disposable electrodes.

### **WARNING**

1. The disposable electrodes can only be used for one time.
2. The clip electrodes should be used together with the alligator clips.

## 3.5 Inspection Before Test

In order to avoid safety hazards and get good ECG records, the following inspection procedure is recommended before operation.

### 1) **Environment:**

- ◆ Make sure that there is no electromagnetic interference source around the equipment, especially large medical electrical equipment such as electrosurgical equipment, radiological equipment, magnetic resonance imaging equipment etc. Switch off these devices when necessary.
- ◆ Keep the examination room warm (above 18°C) to avoid muscle action voltages in ECG signals caused by cold.

**2) Power Supply:**

Check whether the power cord is connected well. The grounded outlet should be used.

**3) Ground Connection**

Check whether the ground cable is firmly connected.

**4) Patient Cable:**

Check whether the patient cable is connected to the ECG sampling box firmly, and keep it far away from the power cord.

**5) Electrodes:**

- ◆ Check whether all electrodes are connected to lead wires of the patient cable correctly.
- ◆ Ensure that the electrodes do not contact.

**6) Patient:**

- ◆ The patient should not come into contact with conducting objects such as earth, metal parts etc.
- ◆ Ensure the patient is warm and relaxed, and breathes calmly.

## Chapter 4 ECG Sampling

Plug in the right sentinel, and double-click  on the screen to start the software. The main screen will be displayed as follows:

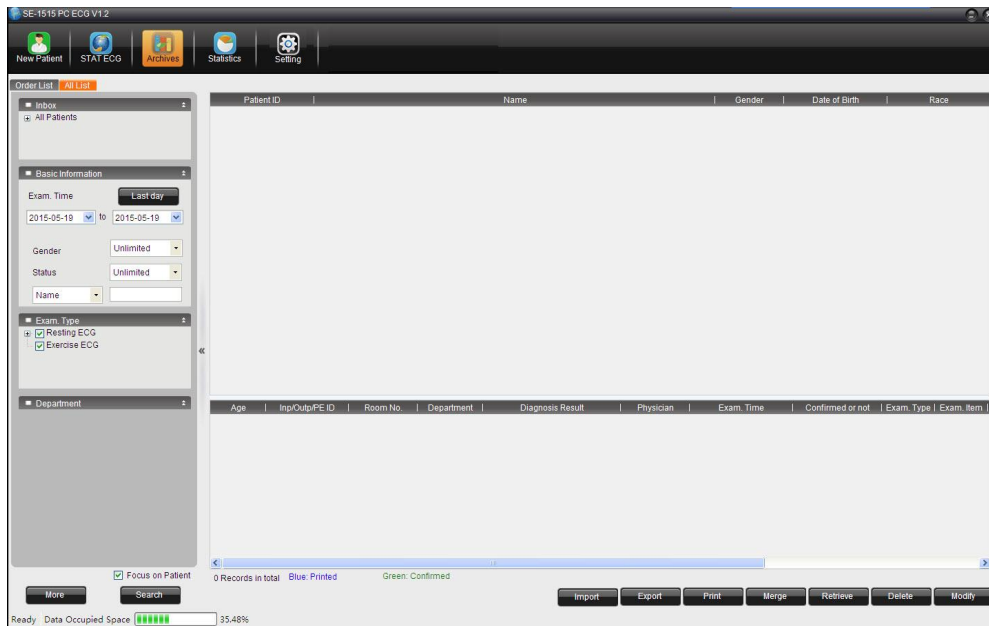

Figure 4-1 Main screen

### 4.1 Initial Configuration

When the software is started the first time after installation, an **Initial Setting** window will be displayed, and you can configure parameters such as the hospital name, lead mode, and sequence.

**NOTE:** If you need to reinstall the software, reinstall it under the original directory. Otherwise, you will have to reconfigure it.

### 4.2 Entering Patient Information

You can enter the patient information with the following two ways:

#### 1. New Patient

Click **New Patient** on the main screen (Figure 4-1), and the **New Patient** window will be displayed as follows:

Figure 4-2 New Patient window

You can also enter the **New Patient** window by clicking **New Patient** on the analysis screen.

## 2. New Order

On the **Archives** screen, click **Order List**, and you enter patient information in the **New Order** area.

**NOTE:** The Order List is not displayed in the Archives screen by default. You have to select **Display Order List** in the **Basic Setting** window of **System Setting**.

### 4.2.1 Entering Patient Information Manually

**NOTE:** Customize\_1/2 can be customized in the **Basic Information** window; pacemaker and other patient information options can be configured in the **Display Setting** window. Before the configuration is complete, these options won't be displayed in the **New Patient** window. For details, see section 8.1.1 and 8.2.

Enter basic information:

You can fill out the basic information of a patient.

If **Pacemaker** is selected on the **Display Setting** window, a checkbox for the pacemaker will be provided on the **New Patient** window. If **Pacemaker** is selected, SE-1515 is very sensitive and can detect very small pacemaker pulses. Therefore, SE-1515 should be placed far from the devices emitting high frequency radiation to avoid interferences on the pacemaker pulse detection and normal ECG acquisition.

#### **NOTE:**

1. In the **New Patient** window, patient ID is a must. You can use the number generated by the system or input a number manually. Patient ID can be a random character string excluding '/', '\', ':', '\*', '?', '<', '>' and '|'.
2. Select **Pacemaker** only when the system is mostly used for patients with pacemakers.

## 4.2.2 Entering Patient Information by Using a Bar Code Reader

The procedure is as follows:

1. Configure the bar code

For more detailed information about configuring the bar code, please contact the manufacturer or the local distributor.

**NOTE:** If the two-dimensional bar code reader is used, you should install Symbol COM Port Emulation Driver manually. For details, please refer to *SE-1515 PC ECG Installation Guide*.

2. Connect the USB bar code reader to the computer.

3. Start the SE-1515 PC ECG software.

4. Use the barcode reader to scan the code:

One-dimensional: Place the cursor on the **Patient ID** in the **New Patient** window or order screen and then scan the barcode.

Two-dimensional: On the **Archives** screen, scan the barcode and the **New Patient** window will be displayed with the patient information filled out automatically; or place the cursor on the patient ID in the **New Patient** window before scanning.

**NOTE:**

1. Only the USB bar code reader recommended by the manufacturer can be used.
2. The USB bar code reader can only read the basic patient information.

## 4.2.3 Retrieve Patient Information

On the **Archives** screen, you can use the following two methods to retrieve the information of a patient recorded before:

Select an order record and click **Exam.**; or select an examination record, and click **Retrieve**.

## 4.3 Selecting the ECG Sampling Type

When creating a new patient record, you can configure the ECG sampling type in the **New Patient** window.

When placing a new order, you can select the ECG sampling type in the **New Order** area. Options provided are **Resting ECG**, **Exercise ECG**, **VCG/SAECG**, and **HRV**.

## 4.4 ECG Sampling

### 4.4.1 Resting ECG Sampling

Click on **OK** after filling out the patient information and selecting the ECG sampling type, the ECG sampling screen will be displayed.

**NOTE:** When placing a new order, if you want to start ECG sampling right after placing the order, select **Start examination after order** in the **Display Setting** of **System Setting**.



Figure 4-3 Resting ECG Sampling

#### 4.4.1.1 Buttons

**NOTE:**

1. You can directly press F1, F4 and F5 on the keyboard to control the ECG sampling screen.
2. The **Stop**, **Keep**, and **Comment** buttons can be used only after the **Start** button is pressed.

Button	Description
Start F1	Once clicked, the system starts sampling and automatically saves the sampled ECG data to the specified directory.
Stop F4	Once clicked, the system stops ECG sampling.

Edit	Once clicked, the <b>New Patient</b> window will be displayed and you can edit the patient information.
Freeze	Once clicked, the frozen window will be displayed. On the displayed window, you can review the ECG sampled before, and print the displayed ECG by clicking on the Print button.
Keep	If this button has been clicked, the system continues the sampling when the sampling time extends the preset time. During the extended sampling, you can click Stop at any time to stop the sampling process, or cancel Keep and finish sampling within the preset time.
Event F5	If this button is clicked, you can mark the sampled waveforms at any time. After the sampling process is complete, you can find the corresponding waveforms with the event marks on the rhythm wave screen. The marked waveforms are stressed with yellow lines.
Settings	If this button is clicked, you can configure the parameters provided on the displayed window.

#### 4.4.1.2 Signal Strength Indication

At the bottom right corner of the ECG sampling screen, a signal strength indication model is displayed.

You can check the placement of each lead according to the signal strength indication model, and identify the signal strength of each electrode based on the background color.

Electrode indication color	<ul style="list-style-type: none"> <li>● Green: The waveforms are good and are free from interferences.</li> <li>● Yellow: The waveforms are interfered.</li> <li>● Red: The lead is off.</li> </ul>
Indication	<ul style="list-style-type: none"> <li>● AAA: Noise type.</li> <li>● BX: Lead</li> </ul> <p>For example, <b>AAA: B1, B2, B3</b> means that the EMG interferences on lead I, II, and V1 are serious.</p>

#### 4.4.1.3 Display Mode Setup

You can configure the display mode, gain, paper speed, filter, lead sequence, and lead mode. Rhythm 1 and Rhythm 3 can be selected for display mode.

The lead order is related to the lead mode. Different lead modes have different lead sequences.

**NOTE:** To pass the distortion test, the ECG workstation has to be configured with the highest bandwidth in filter settings. Otherwise, ECG signal may be distorted.



#### 4.4.1.4 Sample Setup

Click on **Setting** on the resting ECG sampling screen, and the **System Setting** window will be displayed. In the **System Setting** window, click **Sampling Setting** to enter the **Sampling Setting** window.

Parameter	Description
Device Type	Options provided are DP12, DX12, DE15, SE12, DE18, and DEMO. If DX12 is selected, you can view the address of the DX12 wireless receiver after clicking on Receiver Address.
Device Port	You can configure the COM ports used for transmission.
Device ID	You can configure the Device ID. The device number must be within 30 characters.

#### **WARNING**

The device number cannot be changed. Contact the manufacturer if you want to make any modifications on it.

Sampling time	You can configure the sampling time for resting ECG.
Lead mode	Options provided are 9-lead, 12-lead, 15-lead, 16-lead, and 18-lead The 9-lead mode is normally used for pediatric ECG or physical examination.
Lead sequence	Under the 9-lead mode, you can choose Physical mode.

Lead Sequence	Lead Group
<b>Physical mode</b>	I, II, III, aVR, aVL, aVF, V1, V3, V5

Under the 12-lead mode, you can choose from Standard and Cabrera.

Lead Sequence	Lead Group
<b>S a d a r d</b>	I, II, III, aVR, aVL, aVF, V1, V2, V3, V4, V5, V6
<b>C a b r e r a</b>	aVL, I, -aVR, II, aVF, III, V1, V2, V3, V4, V5, V6

Under the 15-lead mode, you can choose from Standard+Right, Standard+Back, Standard+NEHB, Standard+XYZ, and Children mode.

Lead Sequence	Lead Group
<b>Standard+Right</b>	I, II, III, aVR, aVL, aVF, V1, V2, V3, V4, V5, V6, V3R, V4R, V5R
<b>Standard+Back</b>	I, II, III, aVR, aVL, aVF, V1, V2, V3, V4, V5, V6, V7, V8, V9

<b>Standard+NEHB</b>	I, II, III, aVR, aVL, aVF, V1, V2, V3, V4, V5, V6, ND, NA, NI
<b>Standard+XYZ</b>	I, II, III, aVR, aVL, aVF, V1, V2, V3, V4, V5, V6, X, Y, Z
<b>Children mode</b>	I, II, III, aVR, aVL, aVF, V1, V2, V3, V4, V5, V6, V3R, V4R, V7

Under the 16-lead mode, you can choose Standard+Right.

Lead Sequence	Lead Group
<b>Standard+Right</b>	I, II, III, aVR, aVL, aVF, V1, V2, V3, V4, V5, V6, V3R, V4R, V5R, V7

Under the 18-lead mode, you can choose Standard+Right+Back.

Lead Sequence	Lead Group
<b>Standard+Right+Back</b>	I, II, III, aVR, aVL, aVF, V1, V2, V3, V4, V5, V6, V3R, V4R, V5R, V7, V8, V9

Lead electrode Options provided are IEC and AHA.

You can configure it based on the patient cable used.

Display Order Options provided are Simultaneously and Continuously.

If continuously is selected, the lead group will be displayed group by group.

If simultaneously is selected, all the leads will be displayed at the same time.

QRS Sound Options provided are ON and OFF.

AC Filter It is used to protect on the ECG signals from the interferences of the AC power.

Options provided are OFF, 50Hz, and 60Hz.

Select 50Hz/60Hz, AC50/AC60 will be printed on the report respectively.

DFT Filter It is used to ensure that the ECG signals are on the same level during sampling.

The value configured for DFT filter will be printed on the report.

Auto Diagnosis Options provided are Display Standards, Display Normal ECG only, Display All and OFF.

If Display Standards is selected, the system generates the automatic diagnosis result after the sampling is complete.

If Display Normal ECG only is selected, the system only generates the diagnosis result for the normal ECG after the sampling is complete.

If Display All is selected, the system generates automatic diagnosis results for

all analysis screens.

If OFF is selected, the system does not generate any automatic diagnosis results after the sampling is complete.

Enter the

analysis screen when sampling finishes If this function is selected, the system automatically switches to the analysis screen after the sampling is complete.

Auto print

when sampling finishes If this function is selected, the system automatically prints the report after the sampling is complete.

#### 4.4.1.5 Print Setup

Click on **Setting** on the resting ECG sampling screen, and the **System Setting** window will be displayed. In the **System Setting** window, click **Print Setting** to enter the **Print Setting** window.

Item	Description
Report Setting	<p>You can configure the information to be displayed on the print preview screen and the report to be printed.</p> <p>The options provided are: <b>Normal ECG Report</b>, <b>Detailed Report</b>, <b>Template Report</b>, <b>Rhythm Wave Report</b>, and <b>VCG Report</b>.</p> <p>If <b>Template Report</b> is selected, the <b>Feature Point Location</b> option will be displayed. When Feature Point Location is selected, 5 measurement lines will appear on the average template waveforms. However, this only applies to the average template report for resting ECG.</p> <p><b>VCG Report</b> is available only when <b>Enable Vector Calculation</b> is selected in the <b>Function/Algorithm Setting</b> window.</p> <p>If VCG Report is selected, the option <b>XYZ Wave</b> will appear.</p>
Current Template	<p>Three templates are provided by default and cannot be deleted. However, you can edit the default templates and save them as new templates.</p>
Rhythm Lead	<p>You can set <b>Rhythm 1</b>, <b>Rhythm 2</b>, and <b>Rhythm 3</b> to any one of the leads in the current lead mode.</p>
Wave Width, Grid Width	<ul style="list-style-type: none"> <li>You can set <b>grid (1mm)</b> and <b>grid (5mm)</b> to 1, 2, 3, 4, 5, or No respectively.</li> </ul> <p>A larger value means that the grid printed is wider.</p> <p>When <b>No</b> is selected, no grid will be printed.</p>

- The wave width can be set to 1, 2, 3, 4, or 5.

A larger value means that the waveforms printed are wider.

**NOTE:** This parameter affects the printing only, the waveforms displayed on the screen remains the same.

---

#### Print Setting

- **Sequence** can be set to **sequential** or **synchronous**.
    - If **sequential** is selected, the lead group will be sampled group by group.
    - If **synchronous** is selected, all the leads will be sampled at the same time.
  - **Paper Orientation** can be set to **Landscape** or **Portrait**.
  - **Paper Size** can be set to **A4** or **Letter**.
  - **Baseline Adjustment** can be set to **OFF**, **Auto**, or **Horizontal**.
    - If it is set to **Horizontal**, the baseline for leads on the same level is in the same line.
    - If it is set to **Auto**, the system automatically adjusts the baseline for each lead group.
    - If it is set to **OFF**, the system adjusts the baseline for each lead group to an average value.
  - If Auto Gain Control (AGC) is selected, the gain will be adjusted automatically, and the **Baseline Adjustment** is set to **Horizontal** automatically.
  - If the printing color is set to color, the background grid will be printed in color.
 

**NOTE:** If the printing color is set to color, but a black-and-white printer is used, the report printed will be illegible.
  - If **Print after diagnosis** is selected, the system automatically prints the report after the diagnosis is complete.
- 

#### 4.4.1.6 Function/Algorithm Setup

Click on **Setting** on the resting ECG sampling screen, and the **System Setting** window will be displayed. In the **System Setting** window, click **Function/Algorithm Setting** to enter the **Function/Algorithm Setting** screen.

Parameter	Description
Enable Vector Calculation	<p>Once enabled, you can view the vector calculation results on the analysis screen for resting ECG.</p> <p><b>NOTE:</b> This function is unavailable in <b>9-Lead</b> mode and <b>Standard+XYZ</b> mode..</p>
Parameter Setting	<ul style="list-style-type: none"> <li>• <b>Axis Calculation Method</b> can be set to <b>Area Method</b> or <b>Amplitude Method</b>.</li> <li>• <b>Tachycardia Criterion (greater than):</b> Manual input, default: <b>100 bpm</b>. When the patient's heart rate exceeds the Tachycardia Criterion, a Tachycardia hint will appear in the diagnosis result, and the HR information will be stressed with red.</li> <li>• <b>Bradycardia Criterion (less than) :</b> Manual input, default: <b>60 bpm</b></li> </ul>
ECG key	<p>Options provided are <b>Start</b> and <b>Forbidden</b>.</p> <p>When <b>Start</b> is selected, the ECG key on the DE15/DE18 sampling box functions as the <b>Start</b> button on the ECG sampling Screen.</p> <p>When <b>Forbidden</b> is selected, there will be no response when pressing the ECG key.</p>

#### 4.4.1.7 Other Setup

Click on **Setting** on the resting ECG sampling screen, and the **System Setting** window will be displayed. In the **System Setting** window, click **Others** to enter the **Others** screen.

Item	Description
Display	<ul style="list-style-type: none"> <li>• When <b>Anti-aliasing</b> is selected, the waveforms displayed or printed will be smoother.</li> <li>• When <b>1mV marker</b> is enabled, the 1mV calibration mark will be displayed at the start of a line of waveforms in the sampling screen or analysis screen.</li> <li>• <b>Grid View</b> can be set to: <ul style="list-style-type: none"> <li>➤ <b>5mm:</b> Only the 5mm grid is displayed on the waveform screens. The 1mm grid will not be displayed.</li> <li>➤ <b>1mm:</b> Both 5mm grid and 1mm grid will be displayed on the waveform screens.</li> <li>➤ <b>1s/1mV:</b> On the waveform screens, 1s is regarded as a grid (5mm) horizontally, and 1mV is regarded as a grid (5mm) vertically.</li> </ul> </li> </ul>

- **No:** No grid will be displayed on the waveform screens.
- **Arrhythmia hint**, can be set to **On** or **OFF**.

If it is set to **On**, when arrhythmia data is sampled during the sampling process, the system will highlight the related waveforms and provides the arrhythmia type.

Printer type      You can select a type of printers in the operating system.

Comment when marking an event      When this function is selected, you can add a mark on an event.

## 4.4.2 STAT ECG

Click on **STAT ECG** on the main screen and you can enter the sampling screen for resting ECG directly. The system automatically generates a patient ID.

**NOTE:** The difference between the resting ECG sampling and STAT ECG sampling is that, during resting ECG sampling, you have to configure information for a new patient or use the information of an existing patient.

All operations for the **STAT ECG** are the same as those for the resting ECG data sampling.

## 4.4.3 Exercise ECG Sampling

**NOTE:** The exercise test duration of SE-1515 can be as long as 2 hours. Normally, the test duration is within 40 minutes.



Figure 4-4 Exercise ECG sampling window

You can configure the display mode, print mode, paper speed, gain, and filter in

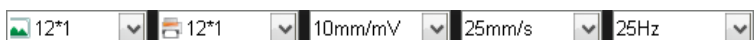

### 4.4.3.1 Buttons

**NOTE:**

1. You can use F1–F9 on the keyboard directly to control the ECG sampling screen.
2. No matter how many changes on the speed or slope you make in a stage, the software only saves the latest one.

Button	Description
Pretest <b>F1</b>	<p>On the presampling screen, you can click <b>Pretest</b> to enter the pretest stage.</p> <p>On the sampling screen, you can click <b>Pretest</b> to move into the next pretest stage.</p>
Exercise <b>F2</b>	<p>In the <b>Pretest</b> stage you can click <b>Exercise</b> to move into the exercise stage.</p> <p>In the <b>Exercise</b> stage, you can click <b>Exercise</b> to move into the next exercise stage.</p> <p><b>NOTE:</b> This function cannot be used when the sampling has been in the last <b>Exercise</b> stage.</p>
Recovery <b>F3</b>	<p>In the <b>Exercise</b> stage, you can click <b>Recovery</b> to move into the <b>Recovery</b> stage.</p> <p>In the <b>Recovery</b> stage, you can click <b>Recovery</b> to move into the next <b>Recovery</b> stage.</p> <p><b>NOTE:</b> This function cannot be used when the test in the last <b>Recovery</b> stage.</p>
Stop <b>F4</b>	<p>Once <b>Stop</b> is clicked, the system stops sampling and refreshes the waveforms, and displays a window.</p> <p>In the displayed window, you can select or manually input the reason for test termination. The reason input manually will be saved as an option for the next time.</p>
Print/Setting <b>F5</b>	<ul style="list-style-type: none"> <li>• In the presampling stage, <b>Setting</b> is displayed.</li> </ul> <p>Click <b>Setting</b> and the <b>Setting</b> window will be displayed. You can configure the related parameters in this window.</p> <p><b>NOTE:</b> The <b>Sample Setting</b>, <b>Print Setting</b>, and <b>Others</b> windows for the exercise ECG are the same as those for the resting ECG. For details, see section 4.4.1.4, section 4.4.1.5, and section 4.4.1.7.</p> <ul style="list-style-type: none"> <li>• During the test, <b>Print</b> is displayed.</li> </ul> <p>Click <b>Print</b> and the system will print the 12-lead waveform report in the last 10s. If the paper used can only be printed with the an ECG of Xs</p>

---

(X<10), the system will print the waveforms in the last Xs.

---

Freeze <b>F6</b>	During the presampling stage and test, <b>Freeze</b> is displayed. Click <b>Freeze</b> and the frozen window will be displayed.
Edit/Event <b>F7</b>	<ul style="list-style-type: none"> <li>• During presampling, you can click <b>Edit</b> to open the <b>New Patient</b> window and edit patient information.</li> <li>• During the test, <b>Event</b> is displayed. You can click it to mark an event.</li> </ul>
BP <b>F8</b>	<p>Click <b>BP</b> in the auto measurement mode, the system will activate the BP monitor and start measuring.</p> <p>Click <b>BP</b> in the manual measurement mode, you can manually input BP in the displayed window.</p>
Start/Stop Tmill <b>F9</b>	<p>Only available in the Exercise and Recovery stage.</p> <p>During the exercise test, you can click <b>Stop Tmill</b> to cool down the treadmill and stop the exercise test temporarily, and click <b>Start Tmill</b> to continue the exercise test.</p>
Keep	<p>Click <b>Keep</b> during the exercise test, and the system will maintain the current speed and slope before you click <b>Keep</b> again.</p> <p><b>NOTE:</b> In the <b>Keep</b> status, the test cannot move into the next stage automatically.</p>
Next	<p>Click <b>Next</b> during the exercise test and the system will move into a new stage.</p> <p><b>NOTE:</b> When the <b>Pretest</b> has lasted for less than 15s, you cannot click <b>Next</b> to move from the <b>Pretest</b> to <b>Exercise</b>.</p>
Speed Up/Speed Down	<p>You can click <b>Speed Up/Speed Down</b> in the <b>Exercise</b> stage to raise/reduce the speed of the treadmill.</p> <p>You can click <b>Speed Up/Speed Down</b> in the <b>Exercise</b> stage to raise/reduce the output of the ergometer.</p>
Slope Up/Slope Down	You can click <b>Slope Up/Slope Down</b> in the <b>Exercise</b> stage to raise/reduce the slope of the treadmill.
Exercise Amount Up/Down	You can click <b>Exercise Amount Up/Down</b> in the <b>Exercise</b> stage to add/reduce 5W exercise amount at one time.

---



### 4.4.3.2 Parameter Information Display

- **Heart rate display**

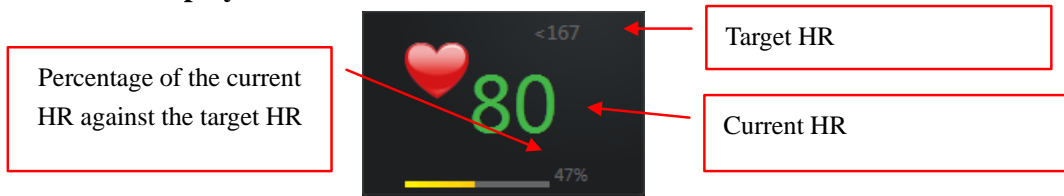

**NOTE:**

1. If the background color of the current HR displayed is yellow, it indicates that the current HR exceeds the target value and should be paid attention to.
2. If the current HR exceeds the target value, you should click **Recovery** to move into the **Recovery** stage and observe the waveforms of in that stage.

- **BP display**

When a BP monitor is connected to the system, the blood pressure display area is as follows:

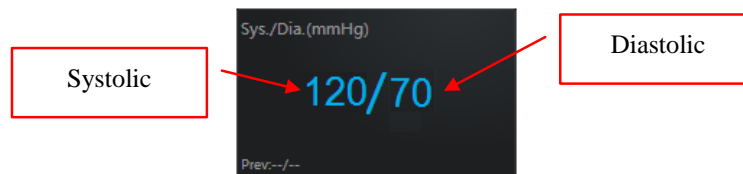

The blood pressure data automatically refreshes regularly according to the configured blood pressure sampling mode. You can click **BP** to manually refresh to the blood pressure.

The normal BP range can be configured in the Setting screen of the exercise ECG.

**NOTE:** If the background color of the blood pressure display area is yellow, it indicates that the current systolic or diastolic is abnormal.

- **Information display area**

If a treadmill is used, the information display area displays the total time, protocol, stage time, stage, speed, slope, PVC/min, Max ST and Min ST, etc.

If an ergometer is used, the information display area displays the total time, protocol, stage time, stage, exercise amount, PVC/min, Max ST and Min ST, etc.

### 4.4.3.3 Average Template

On the sampling screen for exercise ECG, you can click on **Amplify** or **Template** to observe the average template of one or multiple waveforms.

The ST value and ST slope, displayed on the mean wave of each lead, refreshes every 10s. The 3 measurement lines on each mean wave shifts with that of the waveform simultaneously.

You can change the POSTj and the place of the measurement line to adjust the current ST and ST slope for each lead. However, you cannot change the POSTj and the place of the measurement line of the baseline ST.

When you click **Re-identify** after you have manually adjusted the measurement line, the system automatically calculates the place of the measurement line of the Q point and J point and their corresponding ST value and ST slope. The system also refreshes the place of the measurement line of the Q point and J point every 10s.

1. single amplified mean wave

You can manage the lead to be displayed by system scan or manual configuration.

2. multiple original mean waves

In the manual mode, double-click on any mean wave area and the system will automatically switch to its enlarged display window.

3. ST baseline

Right-click on the area of a single amplified mean wave or multiple original mean waves and the system will display the **Accumulate Baseline/Accumulate All**.

- ◆ Select the **Accumulate Baseline** and the baseline mean wave will be folded up to the average template of each lead. This operation is only available during the Exercise stage.
- ◆ Select the **Accumulate All** and the mean wave of all leads will be folded up on the single amplified mean wave window.

#### 4.4.3.4 ST Trend

On the **ST Trend** screen, the ST run charts of 6 leads are displayed. You can right-click to switch between lead groups.

#### 4.4.3.5 Sample Setup

Click on **Settings** on the exercise ECG sampling screen, and the **System Setting** window will be displayed. In the **System Setting** window, click **Sample Setting** to enter the **Sample Setting** window.

In the **Sampling Setting** window, you can

- Configure the model, port number, device ID of the sampling box.
- Configure the parameters of the filter.
- Configure the lead mode, lead sequence, lead electrode, display sequence and QRS voice. In addition, the lead sequence can be edited.
- Select the **Enter the analysis screen when sampling finishes**.
- Select the **Auto print when sampling finishes**.

### 4.4.3.6 Device Setup

Click on **Settings** on the exercise ECG sampling screen, and the **System Setting** window will be displayed. In the **System Setting** window, click **Device** to enter the **Device** window.

Parameter	Description
Device Type	Options provided are <b>Treadmill</b> or <b>Ergometer</b> .
Device Model	You can configure the device model based on the device used. If RUNNER RUN-2011/T treadmill is to be used, set the <b>Device Model</b> to <b>Trackmaster Treadmill</b> .
Protocol	You can configure the protocol based on the device used or customize a protocol. You can click <b>Edit</b> to edit the protocol. For details, see section 4.5.3.7. You can click <b>Restore to factory defaults</b> and the system will to reset the protocols to the default value.
BP monitor	You can set <b>BP monitor</b> to the port that can be used on the computer.
BP Sampling Mode	Options provided are: <ul style="list-style-type: none"> <li>◆ Once per stage The system starts measuring the blood pressure immediately after entering a new stage each time. However, in the <b>Pretest</b> stage, the system only starts the blood pressure measurement in the first 10s of the first stage.</li> <li>◆ Once every three/five/seven minutes After the first time the blood pressure is measured in the pretest stage, that is, the first 10s of the first stage, the system starts the measurement every 3/5/7 minutes.</li> <li>◆ Protocol-Based Control The blood pressure measurement starts as configured in the <b>Protocol Edit</b> screen.</li> <li>◆ Manual Input You have to input the blood pressure data manually.</li> </ul>
Triggering mode	It can be set to <b>Square wave</b> or <b>QRS</b> .
Unit	The unit of <b>Speed</b> can be set to <b>mph</b> or <b>km/h</b> . The unit of <b>Slope</b> can be set to <b>%</b> or <b>degree</b> .
ECG Key	It can be set to <b>Pretest</b> , <b>Print</b> , or <b>Forbidden</b> .

### 4.4.3.7 Protocol Editing

In the **Device** window, select a protocol and click **Edit** to enter the editing window for non-default protocols. In this window, you can change any parameter of each stage or delete the non-default protocols.

### 4.4.3.8 Parameter Setup

Item	Description
Target HR	You can configure the Max predicted HR and the calculation method of the target HR.
Normal BP range	You can configure the systolic and diastolic to the value in the normal range. If the blood pressure of the patient exceeds the configured value, an indication message will be displayed on the main screen and the background color of the blood pressure parameter will be yellow.
POST J	It can be set to <b>Manual</b> or <b>Auto</b> . <b>NOTE:</b> J point is the endpoint of the QRS waveform group and the startpoint of the ST segment. It is also the reference point used by the system to determine the place of the ST segment. Please select the J point based on the actual ECG waveforms of the patient.
ST Standards	When <b>ST Overrun hint</b> is selected, the system will display an indication message <b>ST Overrun</b> when the ST value is detected to be beyond the threshold. You can set the threshold for <b>ST Elevation</b> or <b>ST Depression</b> only after <b>STOverrun hint</b> is selected. <b>ST Elevation</b> can be set to <b>0.05 ~-0.3mV</b> , and <b>ST Depression</b> can be set to <b>-0.05 ~-0.3mV</b> .
Manual Report	Options provided are <b>Print, Print and Save, Save</b> . When <b>Print/Print and Save/Save</b> is selected, you can click <b>Print to Print/Print and Save/Save</b> the corresponding ECG report during the exercise test.
Auto Report	Options provided are <b>OFF, Print, Print and Save, Save</b> . If <b>OFF</b> is selected, the 12-lead report will not be printed automatically on the scheduled auto-print time (configured on the <b>Edit Protocol</b> window) during the exercise test.

	If <b>Print/Print and Save/Save</b> is selected, the 12-lead report of the <b>Exercise</b> stage will be <b>Print/Print and Save/Save</b> .
Event Report	Options provided are <b>OFF, Print, Print and Save, Save</b> . If <b>OFF</b> is selected, the system will not print or save the event marker report during the exercise test, but it will save the event marker report to the summary and analysis screen. If <b>Print/Print and Save/Save</b> is selected, the system automatically print/print and save/save the 12-lead report with comment.
Arrhythmia Report	Options provided are <b>OFF, Print, Print and Save, Save</b> . If <b>OFF</b> is selected, the system will not print or save the arrhythmia report during the exercise test. If <b>Print/Print and Save/Save</b> is selected, the system automatically <b>Print/Print and Save/Save</b> the arrhythmia report.
ECG-Report-ST/ECG -Report-Analysis/Duk e Score/FAI%	If <b>ECG Report-ST, ECG Report-Analysis, Duke Score</b> or <b>FAI%</b> is selected, corresponding information will be contained in the printed report.

#### 4.4.4 VCG Sampling

<b>Buttons</b>	Similar to those of resting ECG. For details, refer to section 4.4.1 "Buttons".	
<b>Sampling Setting</b>	Auto Diagnosis	Options: <b>Display Standard</b> and <b>Off</b> .
	For details about other parameters, refer to section 4.4.1.4 "Sample Setup".	
<b>Print Setting</b>	Report Setting	Options: <b>VCG Report, XYZ Wave TVCG Report</b> and <b>SAECG Report</b> are reserved functions, and are not supported currently.
	Rhythm Lead	Select the lead to be analyzed in the VCG mode.
	For details about other parameters, refer to section 4.4.1.5 "Print Setup".	
<b>Other Setting</b>	For details about other parameters, refer to section 4.4.1.7 "Other Setup".	

#### 4.4.5 HRV ECG Sampling

In the HRV ECG sampling mode, the default sampling time is 5 minutes.

For details about operations and parameter settings, refer to section 4.4.1 "Resting ECG Sampling".

## Chapter 5 ECG Analysis

Three methods can be used to enter the ECG analysis screen:

1. When the ECG sampling time has met the planned value, the system automatically stop ECG sampling and enters the ECG analysis screen.
2. Click **Stop** on the sampling screen, the system will automatically displays the analysis screen.
3. In the patient record area on the **All List** screen, double-click on a record to enter the analysis screen.

When **Resting ECG** is selected, the ECG analysis screen contains the resting ECG, rhythm ECG, and pharma study ECG.

### 5.1 Resting ECG

#### 5.1.1 Wave Analysis

Click **Waveform** to enter the **Waveform** screen for resting ECG. On this screen, you can configure the paper speed, gain, display format, and display order.



Figure 5-1 Resting ECG - Waveform screen

1. Click **Re-sample** and you can resample ECG data on the ECG sampling screen. After resampling, you can click **Comparison** to analyze the comparison results of the two sampled ECG records.

2. Click **Pharma** to open the pharma study screen start pharma study.
  - Test Time Setting
 

In the parameter setup window for pharma study, you can set the report output time mode. The default value is 0-1-3-5-10-15. It means the system will automatically output a report in the beginning, 1st, 3rd, 5th, 10th, and 15th minute. This function is available only when the report format for pharma study is set to **All-Lead ECG Report**.

You can also customize new time modes. A new time mode can contain a maximum of 10 time nodes and the time node value must be no larger than 30. When the customization is started, you should set the time nodes first and then close the customization window.
  - For details about other settings, refer to corresponding parameter descriptions for resting ECG.
3. If you find the hand electrodes or chest electrodes have been placed incorrectly after ECG sampling, you can click **Inversion** to adjust the electrode settings and therefore avoid resampling.
4. Click **Re-analyze** and the system automatically reanalyze the ECG data in the last 10s.
5. The information displayed on the right panel includes measurement information, feature description and diagnosis result.
  - Measurement information: Parameter values can be input manually. If the value is beyond range, it will turn red automatically.
  - Shortcut Keyboard: Used for quick modification on feature description or diagnosis result.
  - Smart input: In the **Feature Description** or **Diagnosis Result** area, you can input only one letter and possible phrases will be provided.
  - Glossary: Click to open the **Glossary** window and you can edit feature description or diagnosis result.
  - History: Click on **History** and you can view all the history diagnosis records of the current patient.
6. Right-click on the waveform area and a shortcut menu will be displayed. Options provided are **R-R (bpm)**, **R-R (ms)** and **Refilter**.
 

Select **R-R (bpm)/ R-R (ms)** and related data will be displayed.

Select **Refilter** and you can modify the parameter values in the **Refilter** window.
7. Double-click on the waveform area, you can view the magnified waveform around the click point on the magnified waveform screen.
  - Click on the lead symbol in the 1mV calibration mark and you can switch leads.
  - The inverted triangles correspond to R waves. Click on an inverted triangle, 5 mark lines will appear around the corresponding R wave and related R, QRS, PR, and QT/QTc information will be displayed. Right click and you can disable the mark lines.

- On the magnified waveform screen, drag the mouse and an electronic measurement ruler (hereinafter called ruler) and corresponding measurement data will be displayed. You can move the ruler by pressing Up/Down/Left/Right arrow keys.

**NOTE:** The mark line and ruler cannot be used at the same time, please right-click to disable either of them first. To enable it, right-click again.

#### 8. VCG:

If **Enable Vector Calculation** is selected in the **Function/Algorithm Settings** window, you can click **VCG** for vector calculation on the resting ECG analysis screen. For details, refer to section 5.3 "VCG".

### 5.1.2 Average Template

Click **Template** to enter the **Average Template** window for resting ECG. In this window, you can analyze the data of waveforms on the **Average Template**.

- When you press **ALL**, magnified average templates of all leads will be overlapped with the same central axis.
- You can set the speed and the gain of average templates.
- You can drag marker lines of P1, P2, Q, S and T on average templates.

P1 is the onset of P wave, P2 is the offset of P wave, Q marks the onset of the QRS wave, S marks the offset of the QRS wave, and T is the offset of the T wave. You can move these lines by dragging on the mouse and the corresponding parameter values will change. You can also use the arrows key on the keyboard to move these marks.

- Reset

After you manually modify the position of a marker line, you can click **Reset** to restore it to the initial position. The ST and ST slope will be automatically updated at the same time.

- Re-diagnose

After you manually modify the position of a marker line, the diagnosis result which is based on the marker line position and corresponding measurement information will not update automatically, you have to click **Re-diagnose** to update to update the diagnosis result.

### 5.1.3 About the Detail Information Window

On the **Average Template** window for resting ECG, click on **Detail Information** at the bottom left corner to enter the **Detail Information** screen.

You can click **Export Excel** to export an Excel file.



## 5.1.4 About the Rhythm Wave Window

Click on **Rhythm** to enter the **Rhythm** screen. On this screen, you can view the rhythm waves.

Item	Description
Event Review	Click to view the strips about arrhythmia and strips saved when marking an event.

## 5.1.5 History Record

On the analysis screen for resting ECG, click **History** and the **History Record** window will be displayed. You can view all the history records of the current user.

Information displayed on the History Record window includes **Exam. ID**, **Exam. Time**, **Exam. Type**, **Exam. Status**, and **Diagnosis Result**. Click on a record and you can view the related information on the analysis screen displayed.

## 5.1.6 About the Parameters

On the analysis screen for resting ECG, if you made any modifications to the parameters, click **Save** to save the modifications.

Common parameters used are listed in the following table:

Designation	Description
HR	Heart Rate
P	P-wave duration
PR	P-R interval
QRS	QRS complex duration
QT/QTc	Q-T interval/Corrected QT interval
P/QRS/T	The electric axis of P/QRS/T wave.
RV5/SV1	The amplitude of R wave of V5 lead/the amplitude of S wave of V1 lead
RV5+SV1	The amplitude of R wave of V5 lead plus the amplitude of S wave of V1 lead
RV6/SV2	The amplitude of R wave of V6 lead/the amplitude of S wave of V2 lead

## 5.2 Exercise ECG

### 5.2.1 About the Summary Screen

#### 5.2.1.1 Stage Information

The stage information includes:

1. Stage information list:

- If a treadmill is used, you can view the information such as stage, stage time, speed, slope, Workload, BP, PVC/min, Max ST and Min ST, etc. in every stage of the exercise test in the list.
- If an ergometer is used, you can view the information such as stage, stage time, exercise time, Workload, BP, HR, DP, PVC, Max ST and Min ST, etc. in every stage of the exercise test in the list.

**NOTE:** Double-click on HR/BP/METs/Max ST/Min ST/PVC/min and you can change its value.

2. Stage time

It indicates the sampling time in a certain stage.

3. HR

The last HR value before entering the next stage is regarded as the HR in that stage.

4. BP

5. Max ST/Min ST

An ST value is calculated and saved every 10s in each stage during the test. The largest value is the Max ST/Min ST in that stage.

6. DP

The DP value changes when the HR or BP value is modified manually.

7. PVC

It refers to the ventricular premature contraction occurred per minute in a certain stage.

**NOTE:** Only integers from 0 to 99 are allowed.

#### 5.2.1.2 Summary Information

On the **Summary Information** area, you can view the protocol of the exercise test, view and change the parameter values and diagnosis information.

1. Protocol information: including protocol name, total protocol time, and total exercise time.
2. Part of the parameters that can be edited are described as follows:

◆ DUKE score

It is automatically calculated by the system and is used to evaluate the follow-up conditions after the exercise test.

DUKE Value	Risk Level
>5	Low
-10~5	Medium
<-10	High

**NOTE:** The DUKE value cannot be changed manually, but it automatically changes after you manually change the Max ST Change or Pectoralgia Type.

◆ HR

Only integers from 0 to 350 are allowed.

◆ BP

When in the unit of mmHg, only integers from 0 to 350 are allowed.

When in the unit of Kpa, the value must be a decimal fraction from 0-46.9, and only one decimal digit is allowed.

◆ Max Workload

The value must be a decimal fraction from 0 to 100.0, and only one decimal digit is allowed.

◆ Max ST/Min ST

Max ST: The value must be a decimal fraction from 0 to 0.80, and two decimal digits are allowed.

Min ST: The value must be a decimal fraction from -0.80 to 0.80, and two decimal digits are allowed.

◆ Max ST Change

The value must be a decimal fraction from 0 to 0.5, and only one decimal digit is allowed.

3. Diagnosis

Every time the sampling for exercise ECG is complete, you can fill out the diagnosis result manually. The diagnosis result must be within 500 characters. When filling out the diagnosis result, you can use a common diagnosis template in the Glossary, or you can customize the glossary.

4. Diagnosis History

Click on **History** and you can view all the history diagnosis records of the current patient.

### 5.2.1.3 Trend

On the summary analysis area, you can view the following:

- HR Trend
- BP Trend
- DP Trend
- Workload Trend

## 5.2.2 About the All View Screen

On the **All View** screen, you can view the ECG wave of one lead throughout the whole test and easily locate the abnormal waveforms. The **All View** screen consists of the Thumbnail ECG Display and Original ECG Display areas.

### 5.2.2.1 Thumbnail ECG Panorama

On the Thumbnail ECG Panorama window, you can view the changes between the heart rate and waveforms during the test.

1. Select wave segment
  - ◆ Click on the waveform area and a rectangle will appear, covering the 10s-waveform centered on where you clicked.
  - ◆ You can press the left or right direction key to shift the rectangle.
2. Select/print thumbnail ECG segment:
  - ◆ Click **Seg Select** and you can manually adjust the startpoint and endpoint for segment printing.
  - ◆ Snapshot: After selecting an ECG segment, you can click **Snapshot** to save the ECG segment, which can be viewed on the **ECG Strip** screen.
  - ◆ Click **Print** to print a report of the selected segment.  
If you select **Single-Lead ECG Report**, the single-lead ECG will be printed; if you select **All-Lead ECG Report**, the **All-Lead ECG Report** in the PSI ECG region will be printed.

### 5.2.2.2 ECG Panorama of Three Rhythm Leads

On the **All View** screen, you can view the primary rhythm lead ECG of a thumbnail waveform. On the rhythm lead ECG area, you can move the rollbar to view all the waveforms.

### 5.2.2.3 12-Lead ECG Panorama

Click **Full Screen** on the **All View** screen and the all view window for 12-lead ECG will be displayed; more information about the leads will be displayed. On the 12-lead ECG panorama window, you can click **Return** to return to the PSI ECG window.

## 5.2.3 About the ECG Strip Screen

### 5.2.3.1 Strip

On the **ECG Strip** screen, you can review:

- ◆ ECG strips printed manually or automatically
- ◆ Snapshots
- ◆ ECG strips with event marks
- ◆ ECG strips with arrhythmia

Multi-selection: You can select multiple strips by clicking the strips one after another.

Edit Label: Click **Edit Label** and you can add a comment to the selected strips (multiple strips can be selected simultaneously).

### 5.2.3.2 12-Lead ECG

Double-click on a strip on the **ECG Strip** window, you can open the corresponding original 12-lead ECG to obtain more detailed information about the waveforms and parameters.

## 5.2.4 ST Analysis

### 5.2.4.1 Average Template

On the **Average Template** window, you can view the ST trend for every 30s or every stage, which can be configured on the right.

When the mouse pointer is settled in a waveform area, the pointer turns into a magnifier image. Click on the waveform and a magnified image will be displayed. The mark lines on the magnified image can be modified by dragging the mouse or pressing the arrow keys.

### 5.2.4.2 Max ST

On the **Max ST** window, you can view the highest ST value and its occurrence time of each lead. When the mouse pointer is settled in a waveform area, the pointer turns into a magnifier image. Click on the waveform and a magnified image will be displayed.

## 5.2.5 ST Trend

On the ST Trend window, you can view:

- ST change trend
- ST trend
- STj trend
- ST slope trend
- ST/HR trend

Click on any point of the curve and you can view the ST value corresponding to the point.

Double-click on any point of the curve and you can open the all-lead waveform screen.

## 5.3 VCG

Vector ECG displays 3D image of ECG activity.

You can choose the plane and the vector loop on the VCG analysis screen. Plane choices include **Frontal**, **Horizontal**, **Sagittal** and **ALL**. Loop choices include **P loop**, **QRS loop**, **T loop** and **ALL**.

Click **Re-analyze** and the system automatically reanalyze the ECG data in the last 10s.



Item	Description
Mode	<ul style="list-style-type: none"> <li>• <b>Auto:</b> The system automatically chooses beats for analysis.</li> <li>• <b>Manual:</b> When enabled, manually click on the triangle symbol displayed on the top to choose beats for analysis.</li> </ul>

### 5.3.1 Displaying Vector ECG with All Plane and All Loop

Set the plane to **ALL** and the loop to **ALL**.

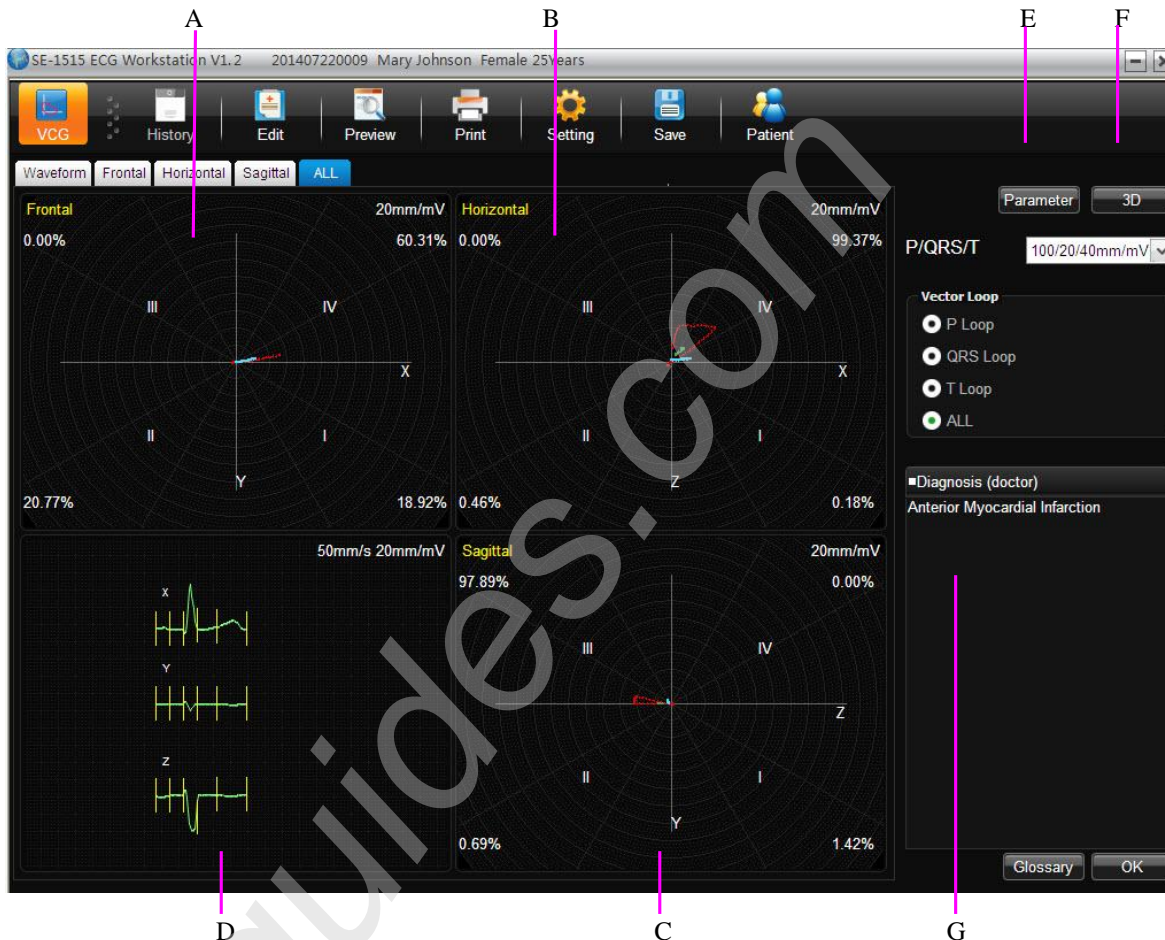

Figure 5-2 Vector ECG - Plane of ALL and Loop of ALL

Figure 5-2 displays Vector ECG with the plane of **ALL** and the loop of **ALL**.

A- Vector ECG of Frontal

B- Vector ECG of Horizontal

C- Vector ECG of Sagittal

D- Average templates of X, Y and Z leads. Double-click on this figure to display the magnified average template. You can drag these lines marked P1, P2, Q, S, T1 and T2 on the wave. With the change of the line position, the corresponding parameter values change.

E- Click on the **Parameter** button to display the following Vector ECG parameter list.

VCG Detailed Measurements							
Ang.:deg Amp.:mV		Frontal		Horizontal		Sagittal	
		Ang.	Amp.	Ang.	Amp.	Ang.	Amp.
P	Max Vector50ms	0	0.04	-43	0.06	183	0.04
	Direction	8		8		8	
QRS	Max Vector37ms	-9	0.67	-37	0.83	187	0.54
	0.01s	159	0.06	132	0.08	19	0.06
	0.02s	-3	0.15	-32	0.18	186	0.09
	0.03s	-8	0.49	-36	0.60	191	0.36
	0.04s	-9	0.64	-39	0.82	191	0.53
	Start vector10ms	159	0.06	132	0.08	19	0.06
	End vector1ms	0	0.03	-80	0.18	180	0.18
	Direction	8		CCW		CCW	
T	Max Vector92ms	-10	0.16	-12	0.16	220	0.04
	ST Vector	-7	0.02	-82	0.15	181	0.14
	Length/Width	16.00		16.67		3.67	
	T-R angle	-1		25		33	
	Direction	8		8		8	
Heart Rate		P		QRS		T	
60 bpm		81 ms		74 ms		169 ms	

Designation	Definition
Max Vector	The position of the maximal amplitude of QRS/P/T loop (ms)
Amplitude	The amplitude of the Max vector of QRS/P/T loop (mV)
Angle	The angle of the Max vector of QRS/P/T loop (degree)
Direction	Rotation direction of QRS/P/T loop
CW	Clockwise
CCW	Counter-clockwise
8	'8' font ring
0.01 (amplitude)	The amplitude at 0.01s from QRS loop
0.01 (angle)	The angle at 0.01s from QRS loop
0.02 (amplitude)	The amplitude at 0.02s from QRS loop
0.02 (angle)	The angle at 0.02s from QRS loop
0.03 (amplitude)	The amplitude at 0.03s from QRS loop



0.03 (angle)	The angle at 0.03s from QRS loop
0.04 (amplitude)	The amplitude at 0.04s from QRS loop
0.04 (angle)	The angle at 0.04s from QRS loop
Start Vector	Start point of QRS loop
End Vector	End point of QRS loop
ST Vector	The position of ST vector in vector loop
Length/Width	The ratio of length to width in T loop
T-R angle	The degree between the Max vector of T loop and the Max vector of QRS loop (degree)

F- Click on **3D** to display the 3D VCG graph.

G- Diagnosis Field

1. Enter your own opinions in the **Diagnosis** textbox, and then click on the **OK** button.
2. Or, double-click on the necessary results required to be added in the **Glossary** textbox, and the selected results will be displayed in the **Diagnosis** textbox, and then click on the **OK** button.

### 5.3.2 Displaying Vector ECG with Frontal Plane and QRS Loop

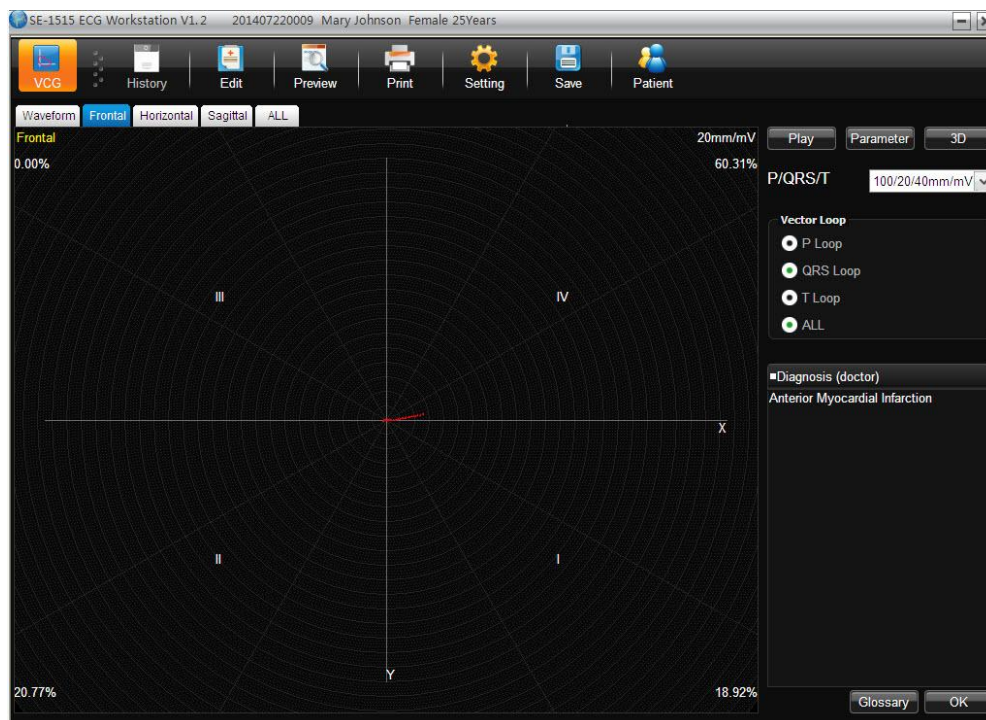

Figure 5-3 Vector ECG - Frontal & QRS loop

The percent values in the square represent the area percentages of QRS loop in every quadrant. **20 mm/mV** indicates the magnified multiple (gain). The red curve is QRS loop.

You can click on the **Zoom in** button or the **Zoom out** button to change the gain of the displayed graphics. You can click on the **Play** button to watch the forming process of the QRS loop.

### 5.3.3 Displaying 3D Vector ECG

Click on **3D** to display the 3D VCG graph.

#### **3D (Three Dimensional Vector Loops)**

This function allows you to observe the Vector ECG in three dimensions.

Select **Rotate**, and then you can rotate the whole picture to view all directions of the vector loops by clicking the mouse.

Select **Axis** to display the axes.

Select **Plane** to display the planes.

Click on **Zoom In/ Zoom Out** to magnify/minify the picture.

Click on **Reset** to restore the magnified/minified picture to original size.

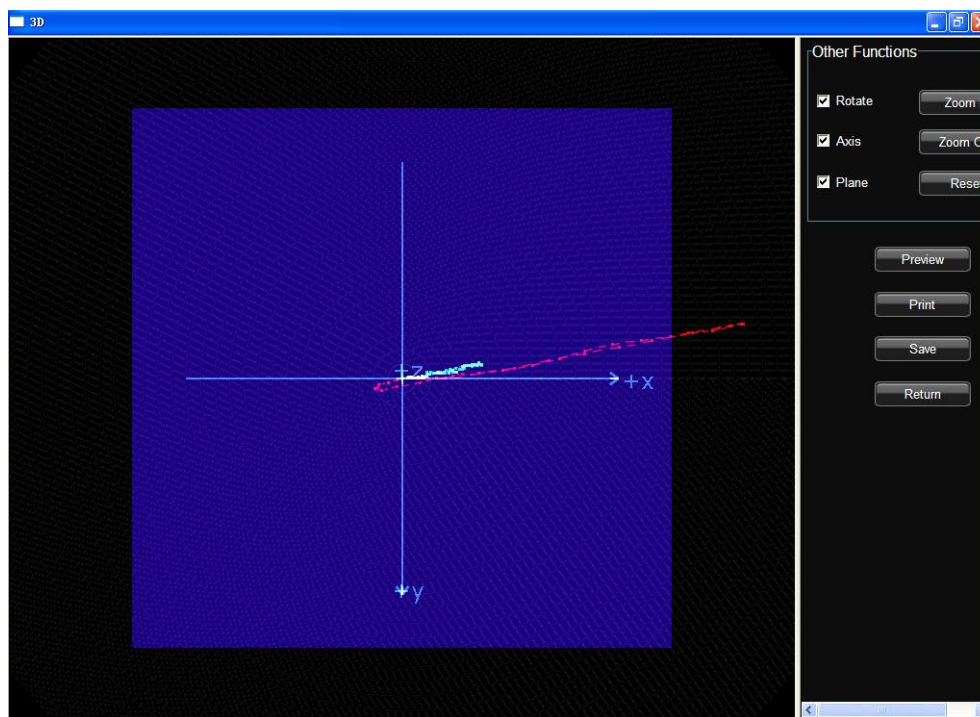

Click on **Preview** to preview the 3D graph.

Click on **Print** to print the 3D graph.

Click on **Save** to save the graph on the current screen.

Click on **Return** to return to the ECG analysis screen.

## 5.4 HRV

The HRV ECG analysis screen includes two tabs: **Auto Diagnosis result** and **Waveform**.

**NOTE:**

1. The HRV sampling time can be set in the **Sample Setting** window.
2. The HRV analysis lead can be selected in the **Sample Setting** window.

Designation	Definition
Sampling Time	Set sampling time
Total Beat Number	Total beat number during the measuring course
Heart Rate	Heart rate
Average RR interval	Average RR interval
Max RR interval	Maximum RR interval
Min RR interval	Minimum RR interval
Max/Min	Ratio of Maximum RR interval to Minimum RR interval
SDNN	Standard Deviation of Normal to Normal Intervals
RMSSD	Root Mean Square Successive Difference
NN50 (the total beat number)	The number of duration difference that is more than 50ms between the adjacent NN durations.
PNN50 (unit: per centum)	NN50 divide the total NN number
SDSD	Standard deviation of successive differences between adjacent normal cycles
TINN	The triangular interpolation of NN interval histogram
Triangle Index	Total NN number divide the NN intervals of the highest percentage
LF	Low Frequency
HF	High Frequency
LF/HF	Ratio of low frequency to high frequency
LF (norm)	Standard LF power
HF (norm)	Standard HF power
Total Power	Total NN difference

### Doctor Diagnosis Field

1. Enter your own opinions in the **Diagnosis** textbox, and then click on the **OK** button.
2. Or, double-click on the necessary results required to be added in the **Glossary** textbox, the selected results will be displayed in the **Diagnosis** textbox, and then click on the **OK** button.

HRV waveform is displayed in the **Waveform** window.

You can drag the mouse in the window to choose the wave field to be previewed or printed. Then click on the **Preview** or **Print** button to preview/print the selected wave field.

## 5.5 Report Previewing

Click **Preview** on a screen and you can open the corresponding preview screen. The following operations can also be performed:

1. Click **Pre Page/Next Page** to move into the previous/next preview screen.
2. Click to zoom in/out the preview area.
3. Click **Print** to print a report using the default printer.
4. Click **Exit** to close the print preview screen and return to its upper-level screen.

## 5.6 Report Printing

Click **Print** on the ECG analysis screen or print preview screen, and the default printer will print the report.

For exercise ECG, click on **Print** on the **Panorama** and **ECG Strip** screen and only the information displayed on the screen will be printed. On other screens, the report configured in the settings window will be printed.

For resting ECG, click on **Print** on the **Event Review** screen, only the ECG strip report will be printed. On other screens, the report configured in the settings window will be printed.

**NOTE:** The printer type is configured in the **Printers and Faxes** by the operating system. You can set **Print Setting** in **System Settings** to **Color**. However, if a black and white printer is used, only black and white reports can be printed.

## 5.7 Saving ECG Reports

You can click on the **Report Save** button to save ECG reports.

The report format includes **PDF**, **WORD**, **JPG** and **BMP**. Click on the **Browse** button to choose the save path and click on **OK** to save the sampled data to the designated directory.

If you select **Send**, the sampled data will be sent by Window Live Mail (Windows 7/Vista) when it is saved to the designated directory.

**NOTE:** In Windows 7/Vista, only if Window Live Mail is installed, can the report be sent by Email.

---

---

**WARNING**

The printouts need to be done with no scaling or sizing done to fit the page.

---

---

## Chapter 6 Archives

### 6.1 All List

Click **Archives** and then click **All List**, the following window will be displayed:

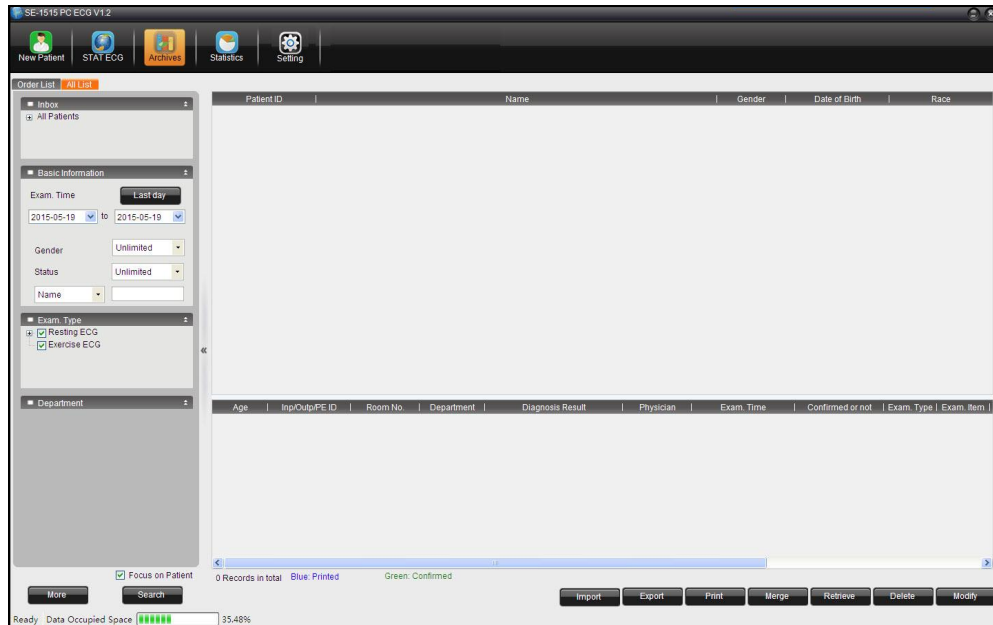

Figure 6-1 Archives window

#### 6.1.1 Record Display

The **All List** screen can be displayed in two ways: focus on examination and focus on patient, which can be configured by selecting or deselecting **Focus on patient**.

#### 6.1.2 Modifying Patient Information

Select a patient record in the patient list and click **Modify**, the **New Patient** window will be displayed. In the displayed window, you can modify the patient information. In this case, modifications are made to all the patient's examination records at the same time.

Select an examination record in the examination record list and click **Modify**, the **New Patient** window will be displayed. In the displayed window, you can modify the patient information. In this case, the modifications are made only to the current examination record and other examination records remain the same.

### 6.1.3 Viewing Examination Records

Double-click on an examination record in the examination record list to open the ECG analysis screen.

You can determine whether the examination record is confirmed by the doctor by checking the examination status in the examination record list.

**Unconfirmed:**

The physician has not confirmed the diagnosis result, that is, the physician did not click on **OK** on the analysis screen to confirm the diagnosis result.

**Confirmed:**

The physician has confirmed the diagnosis result, that is, the physician has clicked on **OK** on the analysis screen to confirm the diagnosis result.

### 6.1.4 Deleting Examination Records

**NOTE:** Data cannot be recovered after being deleted. Be careful when deleting examination records.

Select one or multiple patient records in the patient list and click **Delete** to delete the selected patient records.

Select one or multiple examination records in the examination record list and click **Delete** to delete the selected examination records.

### 6.1.5 Merging Examination Records

Select one or multiple examination records in the examination record list and click **Merge**, the **New Patient** window will be displayed. In the displayed window, fill out the patient ID and click **OK**, the selected examination records will be allocated to the patient.

### 6.1.6 Searching Patient Records

#### 6.1.6.1 Searching Examination Records

Configure the search criteria and click **Search**, all the examination records which meet the search criteria will be displayed on the **Archives** screen.

## 6.1.6.2 Advanced Search

Click **More** and the **Exam. Record Advanced Search** window will be displayed as follows:

## 6.1.7 Import

Click **Select File**, select the right directory and the patient data to be imported, and click **Import** to import the patient data to the **Archives** screen.

**NOTE:** Only ECG data in DAT format can be imported.

## 6.1.8 Export

On the **Archives** screen, click **Export** and select the file format (SCP, FDA-XML, DICOM, and DAT) and directory, and then click **OK** to export the patient data to the specified directory.



## 6.2 Order List

Choose **System Setting** > **Basic Setting**, select **Display Order List**, and restart the system, the **Order List** will be displayed in the **Archives** screen.

The screenshot displays the SE-1515 PC ECG V1.2 software interface. The top menu bar includes icons for New Patient, STAT ECG, Archives, Statistics, Educational, and Setting. The main window is divided into several sections:

- Order List / All List:** A sidebar menu with options for Inbox, Basic Information, Order Time, Gender, Exam Type, and Exam Room.
- New Order Form:** A form with fields for Patient ID (201505190005), Name, Age (Years), Gender (F), Exam Type (Exercise ECG), Exam Item (Exercise ECG), Patient Source (Outpatient), Outpatient, Department, Order Time (2015-05-19), Physician, and Pacemaker (No). There are Clear and OK buttons at the bottom right of the form.
- Order List Table:** A table with columns: Accession Number, Exam ID, Patient ID, Name, Gender, Age, Scheduled Procedure Step Description, Customize\_1, and Dep. One record is visible:
 

Accession Number	Exam ID	Patient ID	Name	Gender	Age	Scheduled Procedure Step Description	Customize_1	Dep
201505190007		201505190004	Mary	F	20Years			
- Search and Status:** A Search button, a status bar showing "1 Records in total", and buttons for Delete, Modify, and Exam. A "Ready" status and "Data Occupied Space 35.48%" indicator are also present.

### 6.2.1 New Order

Fill out the patient information based on the patient and click **OK**. If the order is successful, the patient record will be displayed in the **Order List** below.

### 6.2.2 Inbox

In the inbox, the doctor can quickly locate all the orders that are related to him/her.

### 6.2.3 Searching Information

After configuring the search criteria, click **Search** and all the related order information will be displayed on the right.

## Chapter 7 Statistics

On the toolbar of the main screen, click **Statistics** to enter the **Statistics** window.

The **Statistics** window contains the following categories: Examination Department Workload Count, Request Department Workload Count, Ref-Physician Count, Staff Workload Count, Operating Device Count, Cost Count, and Measurement Analysis Count. You can calculate the workload of the department, staff and operating devices, and calculate the cost of each department or doctors, and calculate the patient data.

**NOTE:** The exam records disabled and deleted will not be calculated to workload.

### 1. Statistic criteria

If you want to select a department, tick it in the checkbox before it.

Appoint exam date: You can specify a time range by clicking **Assign** and choose a time.

Or, you can choose the starting date and the ending date in the time selection region.

The default time is Last month.

On the Measurement Analysis screen, if you want to cancel the configured conditions, select the condition to be canceled, and press **Delete**.

### 2. Statistic results

After configuring the statistic criteria, click **Statistics** and the results will be displayed in the list.

Right-click on the title of the Result List, and you can set the item to be displayed or hidden by the pop-up menu. The item with a tick on the left will be displayed. Cancel the tick and the item will not be displayed.

You can change the item sequence by dragging the item to the place you want.

Next time you log on to the system, you will find the item sequence is the same as you set last time.

Click **Export Excel** and the statistic results will be exported as an Excel file.

## Chapter 8 System Setup

Click on the **System Setting** button on the main screen to open the **System Setting** window.

There are eight tabs in the **System Setting** window: Basic Information, Display Setting, Transmission Setting, File Output Setting, GDT Setting, DicomWorklist Setting, Barcode Setting, and Other Setting.

After you modify some information in the **System Setting** window, you can click on **OK** to save these modifications and exit or click on **Cancel** to cancel these modifications and exit.

### 8.1 Basic Setup

Item	Description
Hospital Name and Logo	Enter a hospital name in the Hospital Name textbox and it will be printed on the report.  Click <b>Set Hospital Logo</b> and you can upload the hospital's logo.
Customize_1/2	When you fill in the <b>Customize_1/2</b> textbox, the corresponding items in the <b>New Patient</b> window will change into what is filled.
Memory	Select <b>Memory</b> in <b>Basic Information</b> window, the content of <b>Customize_1</b> in the <b>New Patient</b> window will be saved  If <b>Memory</b> is not selected, the content of <b>Customize_1</b> in the <b>New Patient</b> window will be empty.
ID Generating Method	When the generating method is set to <b>Auto</b> , the patient ID can be automatically generated according to the examination date.  When the generating method is set to <b>Manual Input</b> , you should enter the patient ID manually in the <b>New Patient</b> window.  When the generating method is set to <b>Accumulate</b> , the patient ID can be increased by one automatically. You need to set the format and the starting number for ID.
Display Order List	When selected, the <b>Order List</b> will be displayed on the <b>Archives</b> screen.
Display All List	When selected, the <b>All List</b> will be displayed on the <b>Archives</b> screen.
Refresh Interval	The refresh interval can be configured between 5 and 600s.
Work Mode	Configure the advanced options.

## 8.2 Display Setup

In the Display Setting window, you can select the items to be displayed on the **New Patient** and order window. You can also configure the order function.

## 8.3 Transmission Setup

Item	Description
UART Transmission	Enable UART transmission and select transmission protocol. When <b>Ymodem</b> is selected, choose <b>UART (Ymodem)</b> When <b>EdanSerial</b> is selected, choose <b>UART</b> .
Synchronize ECG Time	When transmitting order records to an ECG machine, the system time of the ECG machine will also be synchronized automatically.
Port	You can configure the COM ports used for serial transmission.
Match Type	Options provided are: <b>Request No., Exam. ID., Patient ID, Outpatient ID, Inpatient ID, Physical Exam. ID,</b> and <b>None.</b> <ul style="list-style-type: none"> <li>• <b>No</b> When examination records are uploaded from the ECG machine, the records will not be matched with the order information.</li> <li>• <b>Request No./Exam. ID./Patient ID/Outpatient ID/Inpatient No.</b> When downloading order information to the ECG machine, the patient ID in the ECG machine must be the same as the <b>Request No./Exam. ID./Patient ID/Outpatient /Inpatient No.</b> of the patient.</li> </ul>
Exam. Device	<ul style="list-style-type: none"> <li>• ECG machine When checking the order information, the system automatically receives data and waits for the data to be transmitted from the ECG machine.</li> <li>• PC sampling box When checking the order information, the system opens the corresponding sampling screen based on the checked item.</li> </ul>
Hint Mode	Options provided are <b>Sound, Blink,</b> and <b>Diaglog Box</b>
Hint Sound	The <b>Hint Sound</b> can be configured only when <b>Hint Mode</b> is set to <b>Sound</b> .
Hint Sound	The <b>Hint Sound Interval</b> can be configured only when <b>Hint Mode</b> is set

Interval	to <b>Sound</b> .  Options provided are <b>Hint once</b> , <b>Hint every 30s</b> , <b>Hint every 60s</b> , <b>Hint every 120s</b> and <b>Continuous Hint</b> .  When <b>Hint once</b> is selected, the system reminds the user only when data is received.
Auto Diagnosis	When this function is selected, the diagnosis results automatically displays on the analysis window after the data has been received.
Reserve Examined Order	When this function is selected, the examined orders will remain in the order list for specified time.
Enter analysis after uploading	When this function is selected, the system automatically switches to the analysis screen after the data has been uploaded.
Deliver after diagnosis	When this function is selected, the status of a record diagnosed on the analysis screen will be changed into <b>Delivered</b> automatically.

## 8.4 Output File Setup

Item	Description
File name Setting	The file name consists of the ID, name, exam time, age, and gender. The default file name is: Patient ID-Name. <b>NOTE:</b> The file name you configured cannot be empty and at least one item has to be selected or set.
Auto export after sampling finishes	When selected, the system will automatically output files in the corresponding format when sampling finishes.
Output when making diagnosis,	When selected, the system will automatically output files in the corresponding format when making diagnoses.
Output path	Click on <b>Browse</b> to specify the output path.

## 8.5 GDT Setup

**NOTE:** This is an optional advanced function. To activate it, please contact the local distributor.

Item	Description
Enable GDT	Select <b>Enable GDT</b> and then select <b>.GDT</b> or <b>.001</b> according to the actual work stream.
GDT Path	Click on <b>Browse</b> to specify a path to exchange files with the EDP.
Input File Name	The command file name sent to the software from the EDP.
Output File Name	The data file name sent to the EDP from the software.
ECG ID	The name allocated to the software by the EDP.
EDP ID	8315 or 8316 in the GDT protocol.
Output GDT file when sampling stops	When selected, the system automatically outputs a GDT file after the sampling is complete.
Output GDT file when making diagnosis	When selected, the system automatically outputs a GDT file after the diagnosis is complete.

## 8.6 DICOM Setup

**NOTE:** This is an optional advanced function. To activate it, please contact the local distributor.

Item	Description
Enable DICOM Worklist	When selected, the DICOM Worklist function will be activated.
Refresh Interval	Set the refresh interval for automatic worklist download.
Upper Download Limit	Set the upper limit of patient records during an automatic download.
Auto Worklist	When selected, the system automatically downloads worklists from the server in batch.
ECHO	Click to test whether DICOM connection is successful.

Server IP/Server Port/Server AE/Client AE	Set Server IP/Server Port/Server AE/Client AE to the server IP/server port/server AE/client AE used for the DICOM Worklist system.
DICOM Store Setting	Set the time when DICOM files are stored to the server.

## 8.7 HL7 Setup

**NOTE:** This is an optional advanced function. To activate it, please contact the local distributor.

The ECG workstation allows obtaining patient information and uploading files through the HL7 workflow.

## 8.8 Barcode Setup

Item	Description
Barcode Setting	Configure the <b>Start Address</b> , <b>End Address</b> , <b>Male Code/Female Code</b> , and <b>Device Port</b> for each sub-item based on the actual situation.  <b>NOTE:</b> Only the USB bar code reader recommended by the manufacturer can be used.

1. If the bar code reader is connected before starting the software, the software automatically detects the reader. In this case, you can use it without port configuration or initialization.
2. If the bar code reader is connected after starting the software, you have to initialize the bar code reader in **System Setting**.
3. If the initialization fails, you have to manually configure the port by performing the following operations:
  - 1) Connect the USB bar code reader to the computer.
  - 2) On the computer, click **Start** and right-click on **My Computer**, and then choose **Manage**.

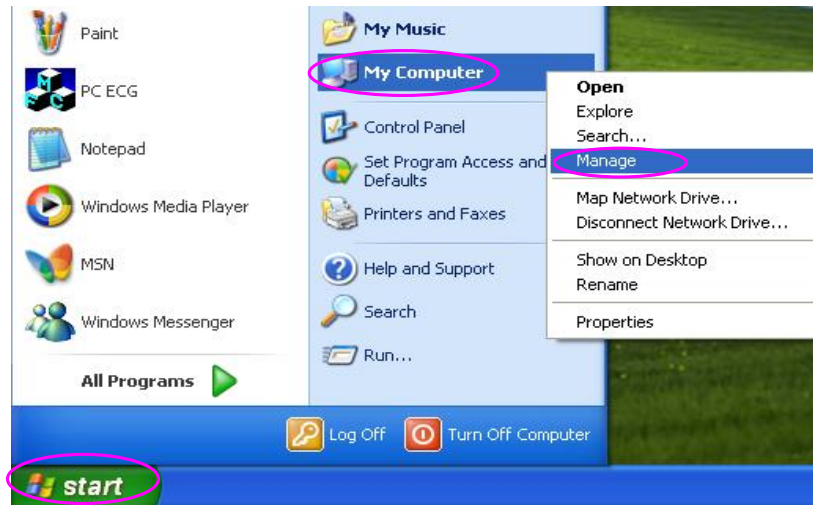

- 3) In the **Computer Management** window, click **Device Manager** and select **Human Interface Devices** to view the ports.

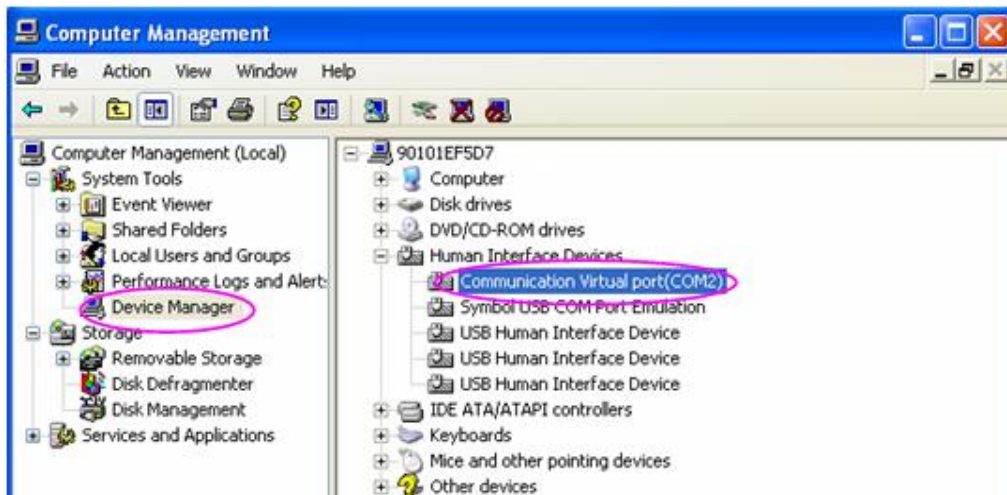

- 4) After setting the device port to the viewed port on the **Barcode Setting** window, click **Yes** to restart the SE-1515 software.

## 8.9 Other Setup

Item	Description
System Maintenance	<ul style="list-style-type: none"> <li>Production Activation</li> <li>System Password Setting</li> </ul> <p>After the password has been changed successfully, you have to enter the new password to enter the <b>System Settings</b> window.</p> <ul style="list-style-type: none"> <li>Advanced Setting:</li> </ul> <p>Refer to section 8.9.2 for details.</p>
Regional Options	The system language, date format, time format, and the unit of blood



---

	pressure, height and weight can be configured.
Theme	To set the system color scheme.
Automatically set	If enabled, the system automatically changes the status of a examination to normal after record from <b>Emergent</b> to <b>Normal</b> after printing its report.
printing	

---

## 8.9.1 Product Authorization

For details, refer to *SE-1515 PC ECG Installation Guide*.

## 8.9.2 Advanced Setting

### 8.9.2.1 Examination Department and Device Management

On the **Exam. Dept. and Device Management** window, fill the device ID to the Device ID column and configure the **Parent Department** and **Device Name**. Click **Save (S)** to save the configuration. You can modify the department name, add or delete data entries.

### 8.9.2.2 Examination Type and Item Management

Click on **Exam. Type and Item Management**, you can modify the value and unit of the cost.

### 8.9.2.3 User Management

Click on **User Management** and you can search the list by user ID or user name.

Click **Search** and you can search for user information based on the conditions set.

Under **User List**, you can click **Add (A)** to add new users and set their rights; click **Modify (M)** to modify basic user information.

To switch between multiple user accounts, choose **Setting>Basic Setting**, and select **Enable System Login** in local mode settings.

### 8.9.2.4 Data Maintenance

Click on Data Maintenance, you can perform data backup and recovery settings.

The name of the backup folder does not allow special characters or letters in languages other than English.

### **8.9.2.5 Request Department Management**

Click on **Request Dept. Management**, you can modify the department name, add or delete department data.

## Chapter 9 Hint Information

Hint information and the corresponding causes provided by the system are listed as follows:

Table 9-1 Hint Information and Causes

Hint Information	Causes
Lead off: X	Electrodes fall off the patient or the patient cable falls off the ECG sampling box.
No sentinel detected!	The sentinel is not inserted.
No sampling box detected, enter DEMO display?	The software is started without connecting the sampling box.
Communication failure: Please check whether the USB cable is connected. You can reconnect the USB cable and try it again.	<p>The USB cable is disconnected or the communication between the ECG sampling box and the serial port is interrupted.</p> <ol style="list-style-type: none"> <li>1. Reconnect the ECG sampling box to the PC.</li> <li>2. Click on the <b>Device</b> tab in the <b>System Setting</b> window of the SE-1515 system, and check whether the sampling device is set correctly.</li> <li>3. The USB cable falls off the PC during the sampling process.</li> </ol>
Battery of sampling device is weak, please change the battery after the test.	Battery of DX12 transmitter is low.
Battery is weak, the sampling device is closing.	Battery of DX12 transmitter is low.
Sampling Device is in sleep mode, please press "Power" to activate it.	DX12 transmitter is in sleep mode.
Overload	The direct current offset voltage on an electrode is too high.
Fail to create database!	The system fails to create database.
The current HR has exceeded the target HR!	Current heart rate value exceeds the target heart rate value.
The diastolic BP has exceeded the normal range!	Diastolic blood pressure exceeds the normal BP range.
The systolic BP has exceeded the normal range!	Systolic blood pressure exceeds the normal BP range.

## Chapter 10 Cleaning, Care and Maintenance

Use only the EDAN-approved substances and methods listed in this chapter to clean or disinfect your equipment. Warranty does not cover damage caused by using unapproved substances or methods.

Edan Instruments has validated the cleaning and disinfection instructions provided in this User Manual. It is the responsibility of the healthcare professional to ensure that the instructions are followed so as to ensure adequate cleaning and disinfection.

### 10.1 General Points

Keep your sampling box and accessories free of dust and dirt. To prevent the device from damage, please follow the instructions:

- Use only the recommended cleaning agents and disinfectants listed in this manual. Others may cause damage (not covered by warranty), reduce product lifetime or cause safety hazards.
- Always dilute according to the manufacturer's instructions.
- Unless otherwise specified, do not immerse any part of the equipment or any accessories in liquid.
- Do not pour liquid onto the equipment.
- Do not allow liquid to enter the case.
- Never use abrasive material (such as steel wool or silver polish).
- Inspect the sampling box and reusable accessories after they are cleaned and disinfected.

#### **CAUTION**

If you spill liquid on the equipment or accessories, or they are accidentally immersed in liquid, contact your service personnel or EDAN service engineer.

### 10.2 Cleaning

If the equipment or accessory has been in contact with the patient, then cleaning and disinfection is required after each use.

The validated cleaning agents for cleaning the sampling box and patient cable are:

- Mild near neutral detergent
- Ethanol (75%)
- Isopropanol (70%)

The validated cleaning agent for cleaning the reusable electrodes is:

- Mild near neutral detergent

Cleaning agents should be applied or removed using a clean, soft, non-abrasive cloth or paper towel.

### 10.2.1 Cleaning the Sampling Box

---

---

#### **WARNING**

When the DX12 transmitter is used, turn off the power, disconnect the patient cable, and take out the battery before cleaning.

---

---

1. Wipe the exterior surface of the equipment using a soft cloth dampened with the cleaning solution until no visible contaminants remain.
2. Wipe off the cleaning solution with a fresh cloth or towel dampened with tap water after cleaning until no visible cleaning agent remains.
3. Dry the equipment in a ventilated and cool place.

### 10.2.2 Cleaning the Patient Cable

1. Wipe the patient cable with a soft cloth dampened with the cleaning solution until no visible contaminants remain.
2. Wipe off the cleaning solution with a fresh cloth or towel dampened with tap water after cleaning until no visible cleaning agent remains.
3. Wipe off with a dry cloth to remove residual moisture.
4. Leave the patient cable to air dry.

---

---

#### **CAUTION**

Any remainder of cleaning solution should be removed from the sampling box and the patient cable after cleaning.

---

---

### 10.2.3 Cleaning the Reusable Electrodes (for Resting ECG)

1. Wipe off with a soft cloth to remove residual gel.
2. Wipe the suction bulbs of chest electrodes and the clamps of limb electrodes with a soft cloth dampened with the cleaning solution until no visible contaminants remain.
3. Wipe off the cleaning solution with a fresh cloth or towel dampened with tap water after cleaning until no visible cleaning agent remains.
4. Wipe off with a dry cloth to remove residual moisture.
5. Leave the suction bulbs and clamps to air dry.

## 10.3 Disinfection

To avoid permanent damage to the equipment, it is recommended that disinfection is performed only when it is considered as necessary according to your hospital' regulations.

Clean the equipment and reusable accessories before they are disinfected. The validated disinfectants for disinfecting the sampling box and patient cable are:

- Ethanol (75%)
- Isopropanol (70%)

The validated disinfectant for disinfecting the reusable electrodes is:

- Isopropanol (70%)

If Ethanol or Isopropanol is used for both cleaning and disinfecting, then a new cloth is required to be used for the disinfection step.

### **CAUTION**

1. Do not use high-temperature, high-pressure vapour or ionizing radiation as disinfection methods.
2. Do not use chloric disinfectant such as chloride, sodium hypochlorite etc.
3. Clean and disinfect reusable electrodes after each use.

### 10.3.1 Disinfecting the Sampling Box

#### **WARNING**

When the DX12 transmitter is used, turn off the power, disconnect the patient cable, and take out the battery before disinfection.

1. Wipe the exterior surface of the equipment using a soft cloth dampened with the disinfectant solution.
2. Wipe off the disinfectant solution with a dry cloth after disinfection if necessary.
3. Dry the equipment for at least 30 minutes in a ventilated and cool place.

### 10.3.2 Disinfecting the Patient Cable

1. Wipe the patient cable with a soft cloth dampened with the disinfectant solution.
2. Wipe off the disinfectant solution with a dry cloth after disinfection.
3. Leave the patient cable to air dry for at least 30 minutes.

### 10.3.3 Disinfecting the Reusable Electrodes (for Resting ECG)

1. Wipe the suction bulbs of chest electrodes and the clamps of limb electrodes with a soft cloth dampened with the disinfectant solution.

2. Wipe off the disinfectant solution with a dry cloth after disinfection.
3. Leave the suction bulbs and clamps to air dry for at least 30 minutes.

## 10.4 Maintenance of ECG Sampling Box

### **CAUTION**

Besides the maintenance requirements recommended in this manual, comply with local regulations on maintenance and measurement.

The following safety checks should be performed at least every 12 months by a qualified person who has adequate training, knowledge, and practical experience to perform these tests.

- a) Inspect the equipment and accessories for mechanical and functional damage.
- b) Inspect the safety related labels for legibility.
- c) Verify that the device functions properly as described in the instructions for use.
- d) Test the protection earth resistance according to IEC/EN 60601-1: Limit: 0.1 ohm.
- e) Test the earth leakage current according to IEC/EN 60601-1: Limit: NC 500  $\mu$ A, SFC 1000  $\mu$ A
- f) Test the enclosure leakage current according to IEC/EN 60601-1: Limit: NC 100  $\mu$ A, SFC 500  $\mu$ A.
- g) Test the patient leakage current according to IEC/EN 60601-1: Limit: NC a.c. 10  $\mu$ A, d.c. 10  $\mu$ A; SFC a.c. 50  $\mu$ A, d.c. 50  $\mu$ A.
- h) Test the patient auxiliary current according to IEC/EN 60601-1: Limit: NC a.c. 10  $\mu$ A, d.c. 10  $\mu$ A; SFC a.c. 50  $\mu$ A, d.c. 50  $\mu$ A.
- i) Test the patient leakage current under single fault condition with mains voltage on the applied part according to IEC/EN 60601-1: Limit: 50  $\mu$ A (CF).
- j) Test the essential performance according to IEC/EN 60601-2-25, or methods recommended by the hospital or local distributor.

The data should be recorded in an equipment log. If the equipment is not functioning properly or fails any of the above tests, the equipment has to be repaired.

### **WARNING**

Failure on the part of the responsible individual hospital or institution employing this equipment to implement a satisfactory maintenance schedule may cause undue equipment failures and possible health hazards.

## Chapter 11 Accessories

Accessory	Part Number
DE15 ECG Sampling Box (IEC)	02.01.210720
DE15 ECG Sampling Box (AHA)	02.01.210727
DE18 ECG Sampling Box (IEC)	02.01.211212
DE18 ECG Sampling Box (AHA)	02.01.211213
18-Lead Patient Cable (AHA)	01.57.471393
18-Lead Patient Cable (IEC)	01.57.471394
16-Lead Patient Cable (IEC)	01.57.471306
16-Lead Patient Cable (AHA)	01.57.471305
Adult Chest Electrodes	01.57.040163
Adult Limb Electrodes	01.57.040162
Resting ECG USB Cable	01.13.036134
Portable Bag	01.56.465623
DP12 ECG Sampling Box	02.01.210039
PC ECG&Stress ECG (DX12) Transmitter	02.06.260163
PC ECG&Stress ECG (DX12) Receiver	02.06.260164
DX12 Patient Cable (IEC)	01.57.471278
DX12 Patient Cable (AHA)	01.57.471279
DX12 Patient Cable (IEC)	01.57.471030
DX12 Patient Cable (AHA)	01.57.471055
12-Lead Patient Cable (IEC)	01.57.471500
12-Lead Patient Cable (IEC)	01.57.471613



12-Lead Patient Cable (AHA)	01.57.471499
12-Lead Patient Cable (AHA)	01.57.471614
12-Lead Patient Cable (IEC)	01.57.109850
12-Lead Patient Cable (AHA)	01.57.109851
Pediatric Chest Electrodes	01.57.040168
Pediatric Limb Electrodes	01.57.040169
Disposable Adult Snap Socket Electrode	01.57.471056
Disposable Pediatric Snap Socket Electrode	01.57.471057
Disposable Clip-on Electrode Adapter	01.57.471031
Disposable Snap Socket Electrode	01.57.471046
Snap Electrode Adaptation Cable	01.13.107449
Multi-Function Electrode Adapter	01.57.040172
Clip-on Electrode Adapter	01.57.040173
Patient Cable for Exercise ECG	01.13.036135
DP12 Belt	01.57.106750
DX12 Belt	01.57.471054
DE15 Belt	01.56.465354
Smart ECG Viewer Dongle	02.01.047227
Exercise ECG Dongle	01.18.047229
LS4208 Bar Code Reader (One-Dimension)	01.23.068023
1900GSR-2 Bar Code Reader (Two-Dimension)	21.18.052311

**NOTE:**

1. Smart ECG Viewer Dongle and Exercise ECG Dongle are used for supporting the authorization of the data management and Exercise ECG function.
2. The part name may vary depending on context, but the part number is constant.

<b>Recommended Optional Accessories</b>	
Treadmill:	Model: TM-400 Manufacturer: EDAN INSTRUMENTS, INC. China CE marking
	Model: Valiant Manufacturer: Lode B.V. The Netherlands CE marking
	Model: h/p/cosmos (all medical models) with coscom interface Manufacturer: Full Vision Inc. USA CE marking
	Model: mercury med 4.0, mercury 4.0 Manufacturer: h/p/cosmos sports & medical gmbh Germany CE marking
	Model: RUNNER RUN-2011/T Manufacturer: Runner srl CE marking
	Model: TMX428 Manufacturer: Full Vision, Inc. CE marking
	Ergometer:
Model: ergoselect 100P/100K, ergoselect 200P/200K Manufacturer: ergoline gmbh Germany CE marking	
Model: Corival Manufacturer: Lode B.V. The Netherlands CE marking	
STRESS BP:	Model: Tango M2 Manufacturer: SunTech Medical Inc. USA CE marking

---

---

**WARNING**

---

1. The electrical outlet and the isolating transformer shall only be used for supplying power to the part of the system.
  2. It will harm the wall outlet to connect the non-medical electrical equipment of the SE-1515 system directly to the wall outlet, because the non-medical electrical equipment of the system is intended to be powered by using the electrical outlet and the isolating transformer.
  3. An additional multiple portable socket-outlet or extension cord shall not be connected to the system.
  4. The electrical outlet and the isolating transformer shall not be placed on the floor.
- 
-

## Chapter 12 Warranty & Service

### 12.1 Warranty

EDAN warrants that EDAN's products meet the labeled specifications of the products and will be free from defects in materials and workmanship that occur within warranty period.

The warranty is void in cases of:

1. damage caused by mishandling during shipping.
2. subsequent damage caused by improper use or maintenance.
3. damage caused by alteration or repair by anyone not authorized by EDAN.
4. damage caused by accidents.
5. replacement or removal of serial number label and manufacture label.

If a product covered by this warranty is determined to be defective because of defective materials, components, or workmanship, and the warranty claim is made within the warranty period, EDAN will, at its discretion, repair or replace the defective part(s) free of charge. EDAN will not provide a substitute product for use when the defective product is being repaired.

### 12.2 Contact Information

If you have any question about maintenance, technical specifications or malfunctions of devices, contact your local distributor.

Alternatively, you can send an email to EDAN service department at: [support@edan.com.cn](mailto:support@edan.com.cn).

## Appendix 1 Technical Specifications

### A1.1 Safety Specifications

Comply with:	IEC 60601-1:2005/A1:2012 EN 60601-1:2006/A1:2013 IEC 60601-1-2:2007 EN 60601-1-2:2007/AC:2010 IEC 60601-2-25:2011	
Anti-electric-shock type:	Class II	
Anti-electric-shock degree:	Type CF with defibrillation-proof	
Degree of protection against harmful ingress of water:	Ordinary equipment (Sealed equipment without liquid proof)	
Disinfection/sterilization method:	Refer to the user manual for details (Please see Chapter 10, "Cleaning, Care and Maintenance")	
Degree of safety of application in the presence of flammable gas:	Equipment not suitable for use in the presence of flammable gas	
Working mode:	Continuous operation	
EMC:	CISPR 11, Group 1, Class A	
Patient Leakage Current:	NC	<10 $\mu$ A (AC) / <10 $\mu$ A (DC)
	SFC	<50 $\mu$ A (AC) / <50 $\mu$ A (DC)
Patient Auxiliary Current:	NC	<10 $\mu$ A (AC) / <10 $\mu$ A (DC)
	SFC	<50 $\mu$ A (AC) / <50 $\mu$ A (DC)

### A1.2 Environment Specifications

	Transport & Storage	Working
Temperature:	DP12/DE15/DE18 ECG sampling box: -40 °C (-8 °F) ~ +55 °C (+131 °F)	+5 °C (+41 °F) ~ +40 °C (+104 °F)

	DX12 ECG sampling box: -20 °C (-4 °F)~+55 °C (+131 °F)	
Relative Humidity:	25%RH~93%RH Non-Condensing	25%RH~80%RH Non-Condensing
Atmospheric Pressure:	70 kPa ~106 kPa	86 kPa ~ 106 kPa

### A1.3 Physical Specifications

Dimensions	DE18/DE15 ECG sampling box: 139mm×96mm ×25mm, ±5mm
	DP12 ECG sampling box: 148mm (L) ×100 mm (W) ×40mm (H) , ±2mm
	DX12 transmitter: 63mm(L)×107mm(W) ×23mm(H), ±2mm
	DX12 receiver: 155mm(L)×100mm(W)×30mm(H), ±2mm
Weight	DE15/DE18 ECG sampling box: Approx. 215g
	DP12 ECG sampling box: Approx. 210g
	DX12 transmitter: Approx. 113g (not including battery)
	DX12 receiver: Approx. 173g

### A1.4 Power Supply Specifications

Power Supply:	PC	Operating Voltage: 110V-240V~
		Operating Frequency: 50 Hz/60Hz
	DE18/DE15 ECG Sampling Box	DC 5V
		Input Power: 1 VA(MAX), 0.5 VA(MIN)
	DP12 ECG Sampling Box	5V, 1VA (MAX), 0.5VA (MIN)
	DX12 transmitter	Input Power: 2x1.5V Excell Alkaline AA IEC LR6; Operation life of battery ≥12 hours
DX12 receiver	DC 5V	
	Input Power: 350mW	

## A1.5 Performance Specifications

<b>HR Recognition</b>		
HR Range	30 bpm ~300 bpm	
Accuracy	±1 bpm	
<b>ECG Sampling Box Performance</b>		
Leads	DE18	18 leads
	DE15	16 leads
	DP12/DX12	12 leads
Acquisition Mode	DE18	simultaneously 18 leads
	DE15	simultaneously 16 leads
	DP12/DX12	simultaneously 12 leads
Sample Frequency	DE18/DE15	1kHz (Analysis) 16kHz (Sampling)
	DP12	1kHz (Analysis) 1kHz (Sampling)
	DX12	0.5kHz (Analysis) 10kHz (Sampling)
A/D	DE18/DE15/DP12	24 bits
	DX12	18bits
Resolution	DE18/DE15	0.1575uV/LSB
	DP12/ DX12	2.52uV/LSB
Input Voltage Range	< ±5mVp-p	
Time Constant	≥3.2s	

CMRR	DE18/DE15	$\geq 123\text{dB}$ (AC OFF)
	DP12	$\geq 115\text{dB}$ (AC OFF)
	DX12	$\geq 100\text{dB}$ (AC OFF)
Frequency Response	DE18/DE15	0.01Hz~300Hz (-3dB)
	DP12/DX12	0.05Hz~150Hz (-3dB)
Gain	2.5, 5, 10, 20, 10/5, AGC (mm/mV)	
Input Impedance	DE18/DE15	$\geq 100\text{M}\Omega$
	DP12	$\geq 50\text{M}\Omega$
	DX12	$\geq 20\text{M}\Omega$
Input Circuit Current	$\leq 10\text{ nA}$	
Calibration Voltage	$1\text{mV} \pm 2\%$	
DC Offset Voltage	DE18/DE15/DP12	$\pm 600\text{mV}$
	DX12	$\pm 500\text{mV}$
Minimum Amplitude:	$20\ \mu\text{Vp-p}$	
Noise	DE18/DE15/DP12	$\leq 12.5\ \mu\text{Vp-p}$
	DX12	$\leq 15\ \mu\text{Vp-p}$
Recovery Time After Defibrillation	$< 5\text{ s}$	
Multichannel crosstalk	$\leq 0.5\text{mm}$	
Patient Leakage Current:	NC	$< 10\ \mu\text{A}$ (AC) / $< 10\ \mu\text{A}$ (DC)
	SFC	$< 50\ \mu\text{A}$ (AC) / $< 50\ \mu\text{A}$ (DC)
Patient Auxiliary Current:	NC	$< 10\ \mu\text{A}$ (AC) / $< 10\ \mu\text{A}$ (DC)
	SFC	$< 50\ \mu\text{A}$ (AC) / $< 50\ \mu\text{A}$ (DC)



Insulation		4000Vrms/min	
Filter	AC	DE18/DE15/DX12	50Hz/60Hz/Off
	EMG	DE18/DE15/ DX12	25Hz/35Hz/45Hz/Off
	DFT	DX12	0.05Hz/0.32Hz/0.67Hz
		DE18/DE15	0.01Hz/0.05Hz/0.32Hz/0.67Hz
	LOWPASS Filter	DX12	150Hz/100Hz/75Hz
		DE18/DE15	300Hz/270Hz/150Hz/100Hz /150Hz/100Hz/75Hz
Pacemaker Detection		DE18/DE15	$\pm 750\mu\text{V} \sim \pm 700\text{mV}$ , 50us ~ 2.0ms
		DP12	$\pm 2\text{mV} \sim \pm 700\text{mV}$ , 0.1ms ~ 2.0ms
		DX12	$\pm 2\text{mV} \sim \pm 500\text{mV}$ , 0.1ms ~ 2.0ms
<b>DX12 Bluetooth</b>			
Transmitting Frequency		2402-2480Hz	
Frequency Band		2402-2480Hz	
Modulation Type		FHSS	
Transmitting Power		4.65dBm	
Effective Radiated Power		2.65dBm	

**NOTE:** Operation of the equipment below the minimum amplitude may cause inaccurate results.

## Appendix 2 EMC Information

### Electromagnetic Emissions

<b>Guidance and manufacture's declaration - electromagnetic emission</b>		
SE-1515 PC ECG is intended for use in the electromagnetic environment specified below. The customer or the user of SE-1515 PC ECG should assure that it is used in such an environment.		
<b>Emission test</b>	<b>Compliance</b>	<b>Electromagnetic environment - guidance</b>
RF emissions CISPR 11	Group 1	SE-1515 PC ECG uses RF energy only for its internal function. Therefore, its RF emissions are very low and are not likely to cause any interference in nearby electronic equipment.
RF emission CISPR 11	Class A	SE-1515 PC ECG is suitable for use in all establishments, other than domestic and those directly connected to the public low-voltage power supply network that supplies buildings used for domestic purposes.
Harmonic emissions IEC 61000-3-2	Not applicable	
Voltage fluctuations/ flicker emissions IEC 61000-3-3	Not applicable	

### Electromagnetic Immunity

<b>Guidance and manufacture's declaration - electromagnetic immunity</b>			
SE-1515 PC ECG is intended for use in the electromagnetic environment specified below. The customer or the user of SE-1515 PC ECG should assure that it is used in such an environment.			
<b>Immunity test</b>	<b>IEC 60601 test level</b>	<b>Compliance level</b>	<b>Electromagnetic environment - guidance</b>
Electrostatic discharge (ESD) IEC 61000-4-2	±6 kV contact ±8 kV air	±6 kV contact ±8 kV air	Floors should be wood, concrete or ceramic tile. If floor are covered with synthetic material, the relative humidity should be at least 30%.

Electrical transient/burst IEC 61000-4-4	fast $\pm 2$ kV for power supply lines	Not applicable	Not applicable
Surge IEC 61000-4-5	$\pm 1$ kV line to line $\pm 2$ kV line to ground	Not applicable	Not applicable
Power frequency (50Hz/60Hz) magnetic field IEC 61000-4-8	3A/m	3A/m	Power frequency magnetic fields should be at levels characteristic of a typical location in a typical commercial or hospital environment.
Voltage dips, short interruptions and voltage variations on power supply input lines IEC 61000-4-11	<5% $U_T$ (>95% dip in $U_T$ ) for 0.5 cycle  40% $U_T$ (60% dip in $U_T$ ) for 5 cycles  70% $U_T$ (30% dip in $U_T$ ) for 25 cycles  <5% $U_T$ (>95% dip in $U_T$ ) for 5 sec	Not applicable	Not applicable
<b>NOTE:</b> $U_T$ is the a.c. mains voltage prior to application of the test level.			

### Electromagnetic Immunity

#### Guidance and manufacture's declaration - electromagnetic immunity

SE-1515 PC ECG is intended for use in the electromagnetic environment specified below. The customer or the user of SE-1515 PC ECG should assure that it is used in such an environment.

Immunity test	IEC 60601 test level	Compliance level	Electromagnetic environment - guidance
Conducted RF IEC61000-4-6	$3 V_{\text{rms}}$ 150 kHz to 80 MHz	$3 V_{\text{rms}}$	<p>Portable and mobile RF communications equipment should be used no closer to any part of SE-1515 PC ECG, including cables, than the recommended separation distance calculated from the equation applicable to the frequency of the transmitter.</p> <p><b>Recommended separation distance</b></p> $d = 1.2\sqrt{P}$ <p><math>d = 1.2\sqrt{P}</math> 80 MHz to 800 MHz</p> $d = 2.3\sqrt{P}$ 800 MHz to 2.5 GHz <p>Where <math>P</math> is the maximum output power rating of the transmitter in watts (W) according to the transmitter manufacturer and <math>d</math> is the recommended separation distance in meters (m).</p> <p>Field strengths from fixed RF transmitters, as determined by an electromagnetic site survey <sup>a</sup>, should be less than the compliance level in each frequency range <sup>b</sup>.</p> <p>Interference may occur in the vicinity of equipment marked with the following symbol:</p> 
<p><b>NOTE 1</b> At 80 MHz and 800 MHz, the higher frequency range applies.</p> <p><b>NOTE 2</b> These guidelines may not apply in all situations. Electromagnetic propagation is affected by absorption and reflection from structures, objects and people.</p>			
<p><sup>a</sup> Field strengths from fixed transmitters, such as base stations for radio (cellular/cordless) telephones and land mobile radios, amateur radio, AM and FM radio broadcast and TV broadcast cannot be predicted theoretically with accuracy. To assess the electromagnetic</p>			

environment due to fixed RF transmitters, an electromagnetic site survey should be considered. If the measured field strength in the location in which SE-1515 PC ECG is used exceeds the applicable RF compliance level above, SE-1515 PC ECG should be observed to verify normal operation. If abnormal performance is observed, additional measures may be necessary, such as reorienting or relocating SE-1515 PC ECG.

<sup>b</sup> Over the frequency range 150 kHz to 80 MHz, field strengths should be less than 3 V/m.

**Recommended separation distances between portable and mobile  
RF communications equipment and the EQUIPMENT or SYSTEM**

**Recommended separation distances between  
portable and mobile RF communications equipment and SE-1515 PC ECG**

SE-1515 PC ECG is intended for use in an electromagnetic environment in which radiated RF disturbances are controlled. The customer or the user of SE-1515 PC ECG can help prevent electromagnetic interference by maintaining a minimum distance between portable and mobile RF communications equipment (transmitters) and SE-1515 PC ECG as recommended below, according to the maximum output power of the communications equipment.

Rated maximum output power of transmitter (W)	Separation distance according to frequency of transmitter (m)		
	150 kHz to 80 MHz $d = 1.2\sqrt{P}$	80 MHz to 800 MHz $d = 1.2\sqrt{P}$	800 MHz to 2.5 GHz $d = 2.3\sqrt{P}$
0.01	<b>0.12</b>	<b>0.12</b>	<b>0.23</b>
0.1	<b>0.38</b>	<b>0.38</b>	<b>0.73</b>
1	<b>1.2</b>	<b>1.2</b>	<b>2.3</b>
10	<b>3.8</b>	<b>3.8</b>	<b>7.3</b>
100	<b>12</b>	<b>12</b>	<b>23</b>

For transmitters rated at a maximum output power not listed above, the recommended separation distance  $d$  in metres (m) can be estimated using the equation applicable to the frequency of the transmitter, where  $P$  is the maximum output power rating of the transmitter in watts (W) according to the transmitter manufacturer.

**NOTE 1** At 80 MHz and 800 MHz, the separation distance for the higher frequency range applies.

**NOTE 2** These guidelines may not apply in all situations. Electromagnetic propagation is affected by absorption and reflection from structures, objects and people.

## Appendix 3 Abbreviations

<b>Abbreviation</b>	<b>Full Description</b>
LCD	Liquid Crystal Display
BP	Blood Pressure
ECG	Electrocardiogram/Electrocardiograph
HR	Heart Rate
AC	Alternating Current
USB	Universal Serial Bus
AGC	Auto Gain Control
NC	Normal Condition
SFC	Single Fault Condition

P/N: 01.54.455911

MPN: 01.54.455911018



**EC REPRESENTATIVE**

Shanghai International Holding Corp. GmbH (Europe)

Eiffestrasse 80, D-20537 Hamburg Germany

TEL: +49-40-2513175 FAX: +49-40-255726

E-mail: [shholding@hotmail.com](mailto:shholding@hotmail.com)

**EDAN INSTRUMENTS, INC.**

#15 Jinhui Road, Jinsha Community, Kengzi Sub-District

Pingshan District, 518122 Shenzhen, P.R.China

Email: [info@edan.com.cn](mailto:info@edan.com.cn)

TEL: +86-755-2689 8326 FAX: +86-755-2689 8330

[www.edan.com.cn](http://www.edan.com.cn)